



Automation for a Changing World

# Delta AC Servo Drive & Motor ASDA-A3 Series

# Delta High-end Servo System ASDA-A3

More Responsive, Better Accuracy and  
Remarkable Robust Control





## Table of Contents

<b>Cutting-edge Specification</b>	<b>1</b>
<hr/>	
3.1 kHz bandwidth 24-bit absolute type encoder High speed motor with 6,000 r/min and 350 % peak torque Motor with high or low inertia rotor Low cogging torque motors Supports a variety of motors Full-closed loop control function	
<b>System Tuning and Safety Functions</b>	<b>2</b>
<hr/>	
System diagnosis function Low frequency vibration suppression function Auto-tuning function Advanced notch filters Safe Torque Off (STO) function	
<b>Motion Inside</b>	<b>7</b>
<hr/>	
Advanced motion commands Built-in camming functions Capture and compare functions	
<b>Energy-Saving and Compact Size Design</b>	<b>8</b>
<hr/>	
DC-bus sharing feature Thinner size servo drives Smaller size servo motors	
<b>Smart and Intuitive Software Interface</b>	<b>9</b>
<hr/>	
Tree-view index window Graphical interface for parameter settings Auto-tuning wizard for gains Advanced gain tuning interface System analysis in Bode Plot Oscilloscope function Graphical programming interface of PR mod	
<b>Product Information</b>	<b>11</b>
<hr/>	
Part Names and Functions Optional Accessories ASDA-Soft Configuration Software Servo Motor Features	
<b>Ordering Information</b>	<b>18</b>
<hr/>	
Product Line Up Servo Drive Model Name Explanation Servo Drive Specifications Servo Drive Dimensions ECM-A3 Servo Motors Model Name Explanation ECM-A3 Servo Motors Specifications ECM-A3 Servo Motors Dimensions ECMC Servo Motors Model Name Explanation ECMC Servo Motors Specifications ECMC Servo Motors Dimensions Servo Drive Accessories Combinations Optional Cables and Connectors	
<b>Wiring</b>	<b>43</b>
<hr/>	



# Cutting-edge Specifications

## 3.1 kHz Bandwidth

- ▶ Higher responsiveness and shorter settling time could increase productivity

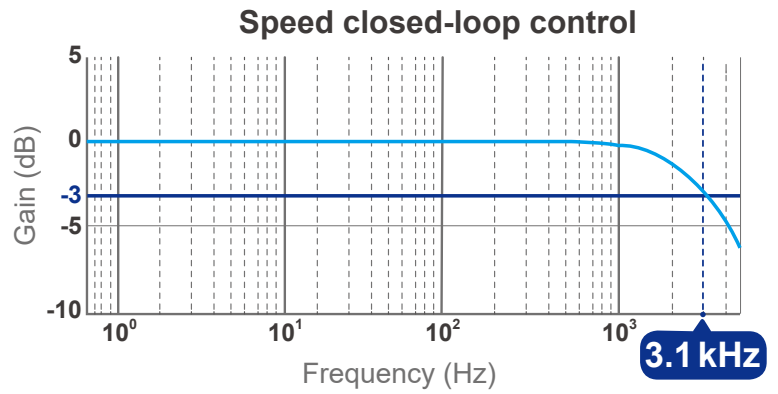
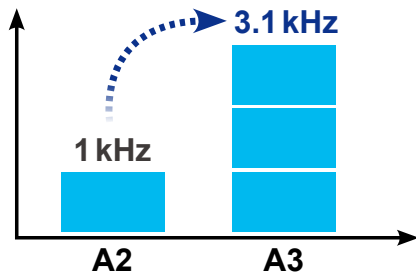

## 24-bit Absolute Type Encoder

- ▶ The positioning precision is enhanced by the 16,777,216 pulses/turn encoder
- ▶ The speed variance in low speed is reduced
- ▶ Absolute type encoder keeps motor's position when power is off

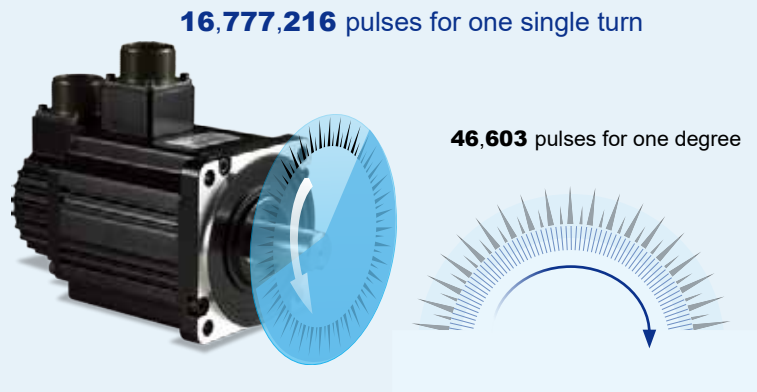

## High speed motor with 6,000 r/min and 350 % peak torque

- ▶ A3 motor can accelerate and decelerate faster with its design

- ▶ This specification is available for motor frame size 40 mm, 60 mm and 80mm

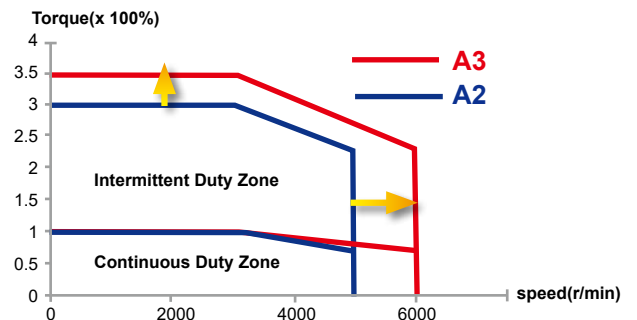
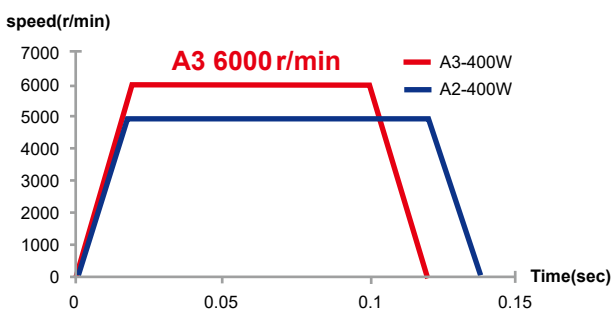

## Motor with high or low inertia rotor

- ▶ For application requiring stable rotating speed and better disturbance resistant capability, a high inertia motor is more suitable, such as machine tools
- ▶ For application like reciprocating motion and fast positioning request, a low inertia motor can be used, such as electronic manufacturing machines

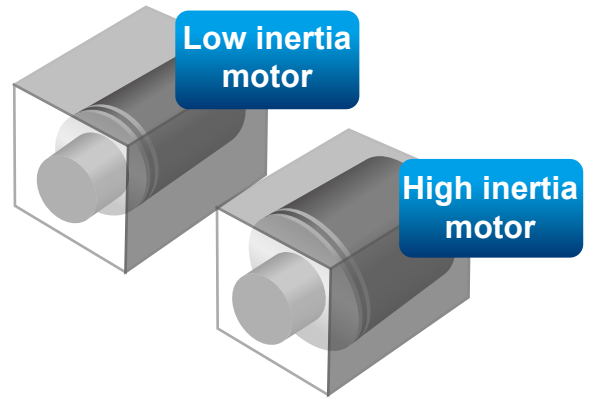

## Low Cogging Torque Motor

- ▶ Cogging torque of the ECM-A3 motor is only 1.5% of the rated torque, which brings smoother operating speed and increases the stability when machining at low speed

Cogging Torque (under 1.5%)

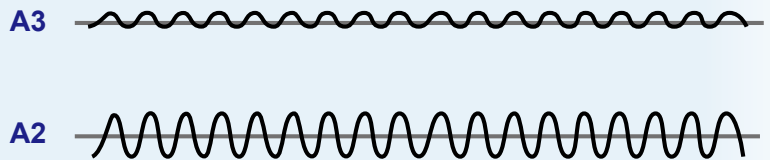

## Supports a Variety of Servo Motors

- ▶ Backward compatibility design for motor to meet future replacement
- ▶ ASDA-A3 drive can support both A2 (ECMA) and A3 (ECM-A3) series motors

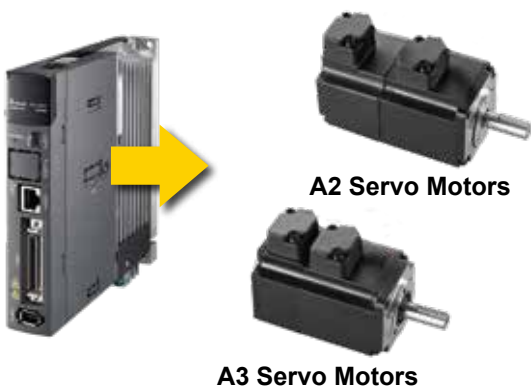

## Full-Closed Loop Control

- ▶ To ensure the positioning accuracy at the end and eliminate the effect of transmission backlash, full-closed loop control function is an effective solution

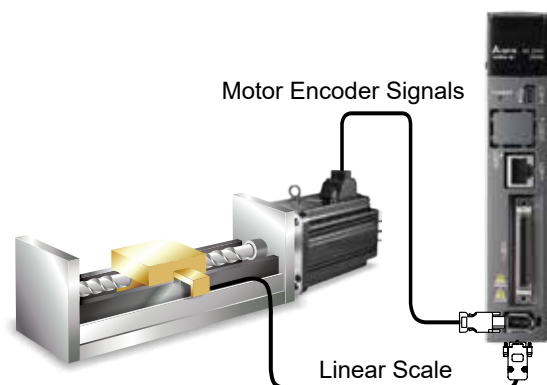

# System Tuning and Safety Functions

## System Diagnosis Function

- ▶ The rigidity of a machine is known through a mathematical model
- ▶ The consistency of the machine's batch installation can be checked
- ▶ By comparing the data from different time span, the wear condition of a machine can be acquired



## Low Frequency Vibration Suppression Function

- ▶ Vibration elimination algorithm is different from command filter and used as a creative algorithm on ASDA-A3
- ▶ The vibration can be eliminated without slowing down its response
- ▶ In addition to vibration elimination algorithm, the two command filters for low frequency vibration are included

### Without Vibration Suppression

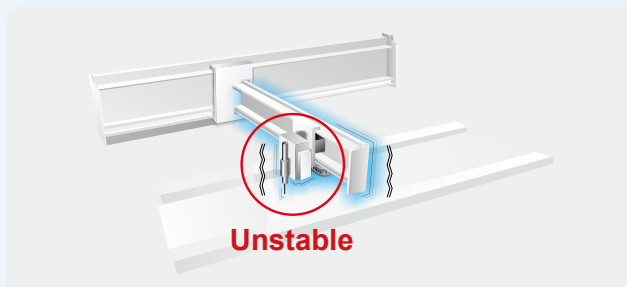

### Delta Vibration Suppression

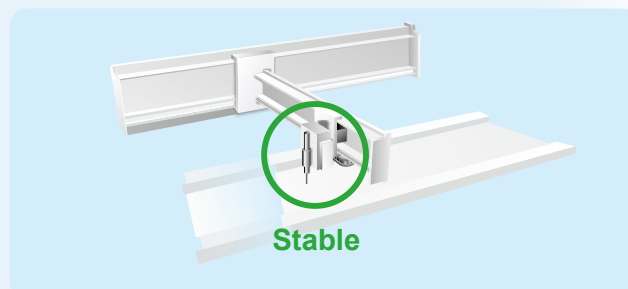

## Auto-Tuning Function

- ▶ Lower the barrier for users to use servo systems
- ▶ This function will optimize the machine performance with less tuning effort
- ▶ It can be done via panel keypad or software

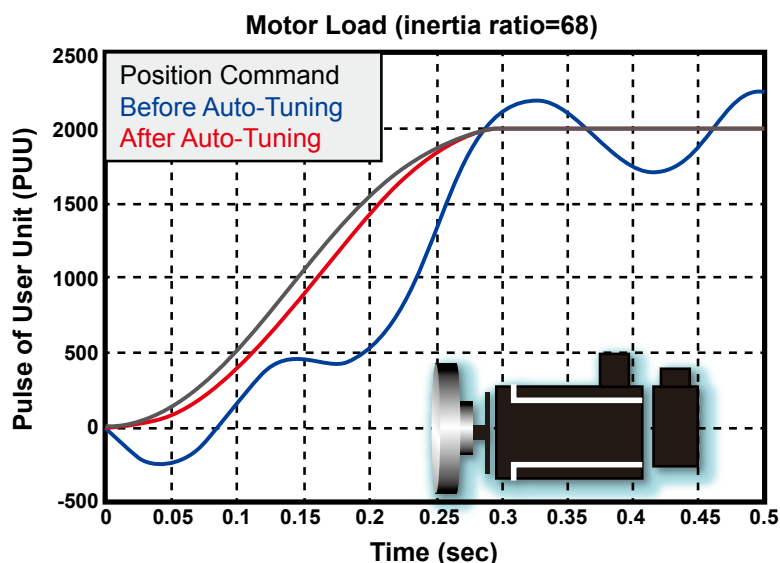

## Advanced Notch Filter

- ▶ There are 5 sets of notch filters with tunable bandwidth and up to 5000 Hz band for ASDA-A3
- ▶ Those filters can search resonance and set the attenuation level automatically
- ▶ With shorter search time for resonance, the machine is less likely to be damaged

## Test Machine Layout

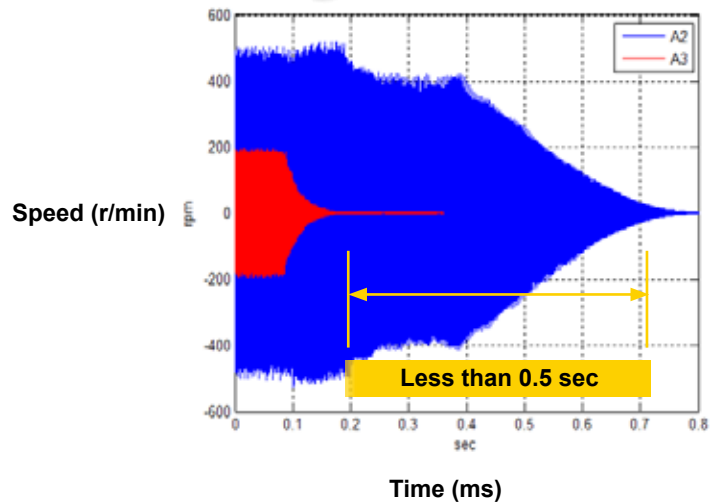
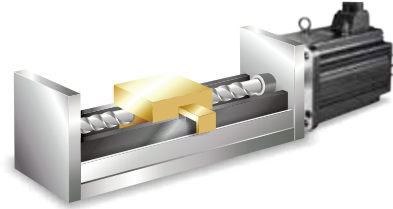

## Safe Torque Off (STO) Function \*note : to be certified

- ▶ Built-in STO (Safe Torque Off) function
- ▶ The motor power will be cut-off when STO is activated

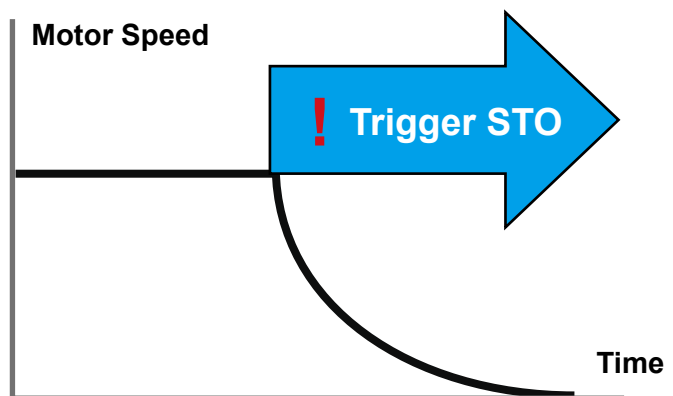
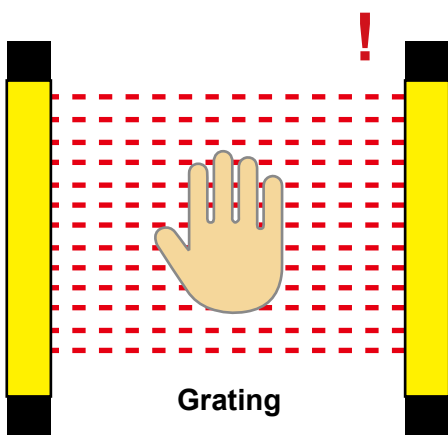

# Motion Inside

## Motion Inside

- ▶ 99 sophisticated motion commands and segments allowed
- ▶ Arithmetic operation and condition jump commands are added
- ▶ Graphical user interface offers simple setup and programming
- ▶ General motion functions like homing, position and speed commands are available
- ▶ Superimposition, blending and on-the-fly change motion commands are provided

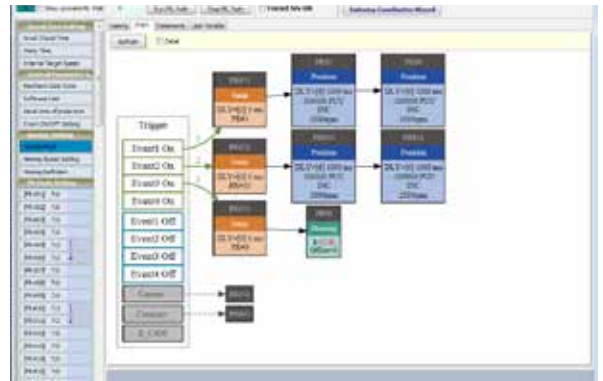

## Built-in Camming Functions

- ▶ E-CAM functions for flying shear and rotary cut are well configured
- ▶ There are maximum 720 points in one cam profile or contour with interpolation smooth algorithm
- ▶ Useful E-CAM phase secure and adjustment functions are easy to apply
- ▶ Many successful applications from ASDA-A2 are available for reference



## Capture and Compare Functions

- ▶ Only 5 μs response time to latch the position or pulse count after receiving the activated DI single.
- ▶ The high-speed DO will response when assigned position or count value is reached after 5 μs response time

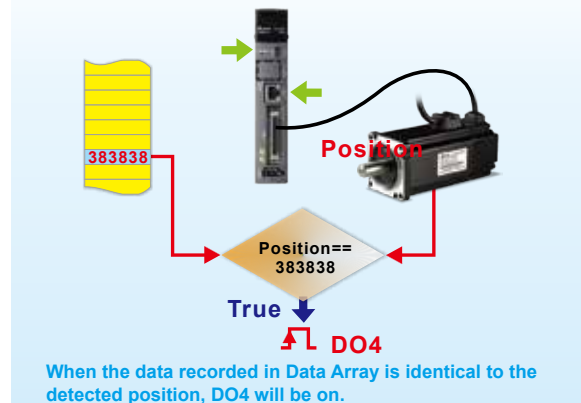
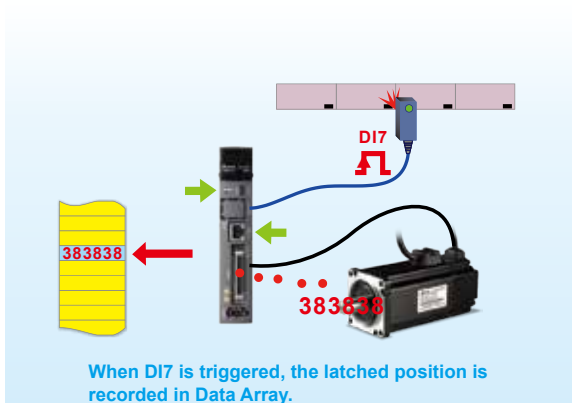



# Energy-Saving and Compact Size Design

## DC-bus Sharing Feature

- ▶ The regenerative energy will be collected to DC-bus for other axes to increase energy efficiency
- ▶ Smaller resistor installed is possible for the system, which can save cost and installation space

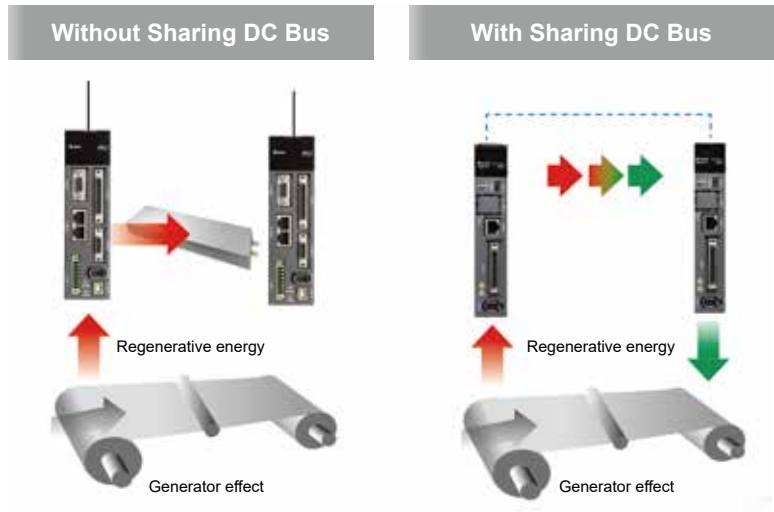

## Thinner Size Servo Drive

- ▶ ASDA-A3 is 20% smaller than A2 on dimensions, which requires less installation space

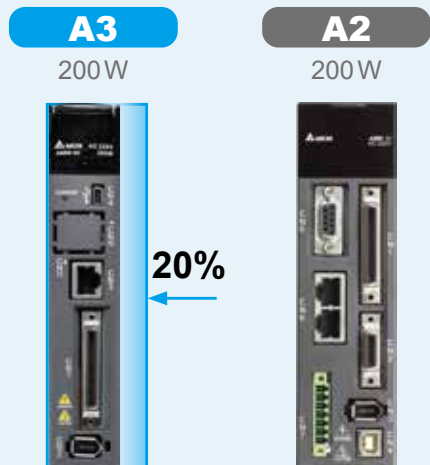

## Smaller Size Servo Motor

- ▶ ASDA-A3 series servo motor is 20% shorter than A2's

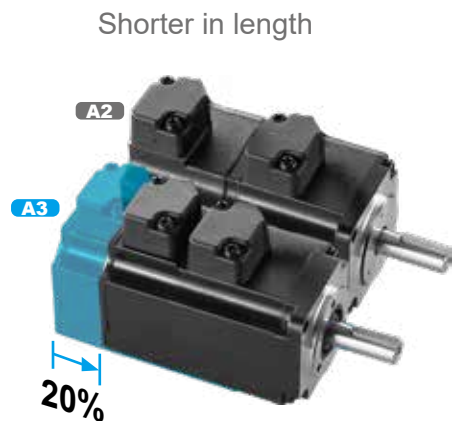

# User-Friendly Software

## Tree-View Index Window

- ▶ Well organized list and collapsible menu help to access functions easily

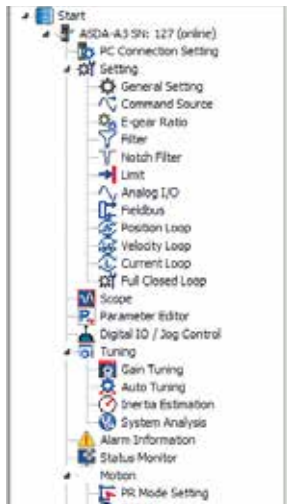

## Graphical Interface for Parameter Settings

- ▶ Intuitive user interface provides set up functions and parameters without manual findings

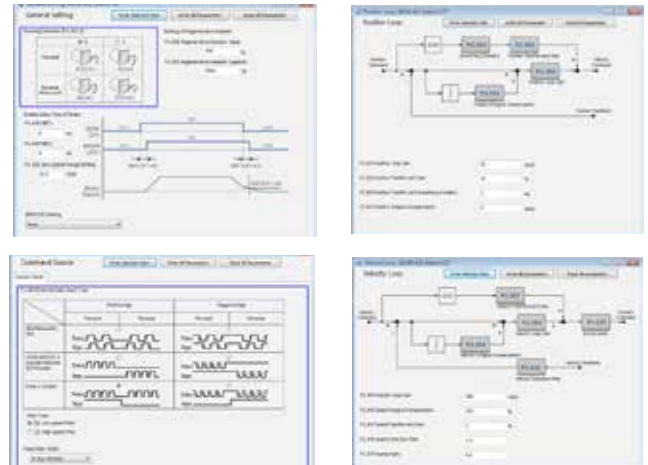

## Auto-Tuning Wizard for Gains

- ▶ Provides step by step guiding wizard for users to tune a servo



## Advanced Gain Tuning Interface

- ▶ The servo gains can be easily fine-tuned for better performance with its well-designed tuning modes



## System Analysis in Bode Plot

### ▪ Speed Open-Loop Mode

Checks the bode plot to know the margin for stability for properly tuned system

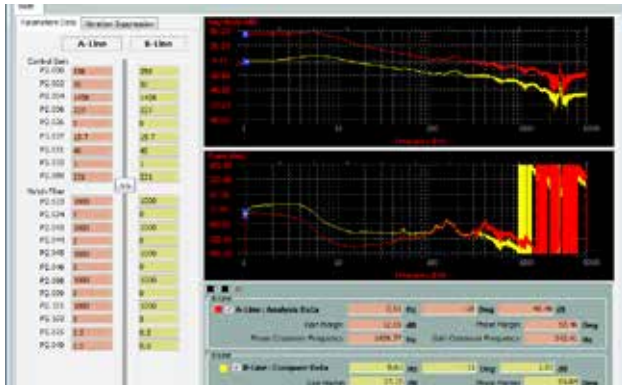

### ▪ System Module Mode

The machine rigidity can be judged from the bode plot in this mode

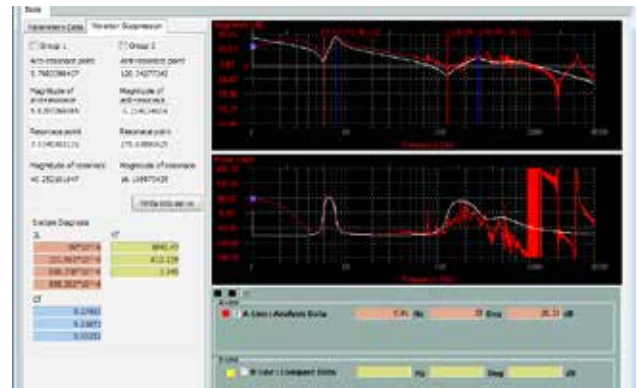

## Oscilloscope Function

- ▶ The channel configurations for applying the PC scope include:
  - 8 channels with 16-bit data size and 10 kHz sampling rate
  - 4 channels with 32-bit data size and 10 kHz sampling rate
  - 4 channels with 16 bit data size and 20 kHz sampling rate

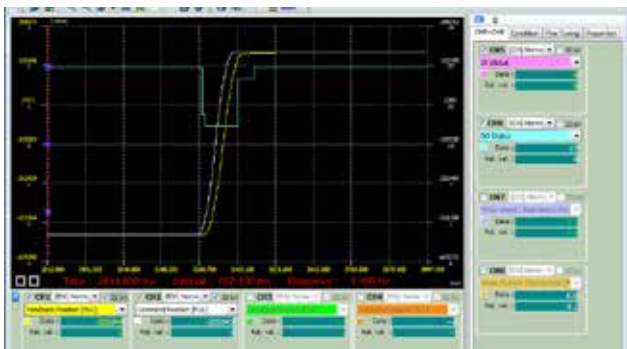

- ▶ Offers FFT (Fast Fourier Transform) function for checking its signal spectrum
- ▶ The RMS value can be calculated by selecting the period of a signal
- ▶ The conditions of start-to-record and stop-recording can be configured

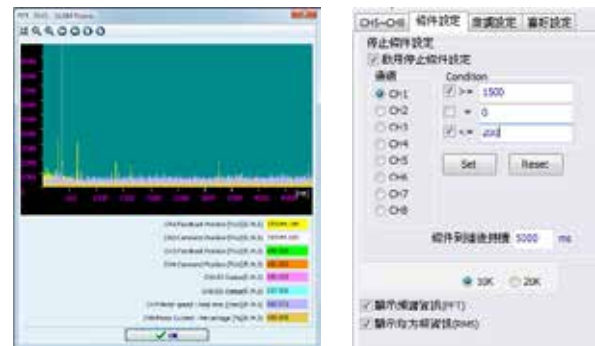

## Graphical Programming Interface of PR mode

- ▶ Allows users to write and trace programs (including jump instructions) easily

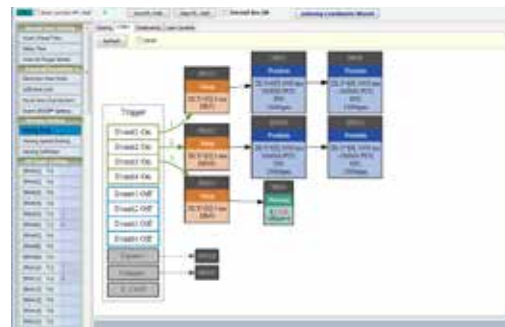

# Product Information

## Part Names and Functions

- **Control Circuit Input Terminal (L1c, L2c)**

- L1c and L2c are used to connect 200~230 VAC, 50/60 Hz single-phase power supply

- **DC Reactor (P1, P2)**

- Without DC reactor: Short circuit P1 and P2
- With DC reactor: connect to P1 and P2

- **Main Circuit Input Terminal (R,S,T)**

- R, S, T are used to connect to main circuit of the servo drive
- For 100 W ~ 1.5 kW servo drives: Used to connect 200 ~ 230 VAC, 50/60 Hz single- phase or 3-phase power supply
- For 2 kW ~ 3 kW servo drives: Used to connect 200-230 VAC, 50/60 Hz 3-phase power supply

- **STO (Safe Torque Off )**

\*Note: The STO function is applicable for the -M/-E models

- STO switch
- Connect to safety switch

- **PC Connection Port (CN4)**

- Used to connect PCs or notebooks for operating ASDA-SOFT software
- A mini-USB Type B port (Note: combine Delta's USB communication modules, see p.48 for reference)
- A RJ45 port (Note: combine Delta's USB communication modules, see chapter on accessories for reference)

- **RS-485/ CANopen Communication Port Connector (CN3)**

- Modbus communication control for RS-485
- CANopen communication control
- (Note: CANopen series with two communication ports, see p.31 for reference)

- **I / O Connector (CN1)**

- Used to connect Delta's PLC products or other NC controllers

- **Encoder Connector (CN2)**

- Used to connect the encoder of the servo motor

- **Extension Module (CN9)**







- **Full-Closed Loop Control Terminal (CN5)**
  - Used to connect external linear scale or encoder for receiving A,B,Z phase signals
- **Servo Motor Output (U, V, W)**
  - Used to connect servo motor terminal U, V, W. Never connect the output terminal to main circuit power as the AC drive may be damaged beyond repair if incorrect cable are connected to the output terminals
- **Braking Resistor Terminal (P3 DC)**
  - Adopt internal resistor: Ensure the circuit is closed between P3 and D, and the circuit is open between P3 and C (Note: Please refer to table of regenerative resistor specifications for the models with a built-in regenerative resistor from ASDA-A3 User Manual Chapter 2 Selecting Regenerative Resistors)
  - Adopt external resistor: Connect it to P3 and C, and ensure an open circuit between P3 and D
  - When using an external braking unit, connect it to P3  $\ominus$ , ensure an open circuit between P3 and D, P3 and C
- **Ground Terminal**
  - Used to connect grounding wire of power supply and servo motor
- **Heat sink**
  - Used to secure the servo drive and for heat dissipation



# Product Information

## Optional Accessories

- **Quick Connectors**

- Used For 100W to 1.5kW servo drives
- One operating lever is provided for wiring



- **Power Cables**

- 3m, 5m 10m and 20m standard cables are available <sup>\*A3 Series</sup>
- Two types available: with brake and without brake



- **Encoder Cables**

- 3m, 5m, 10m and 20m standard cables are available <sup>\*A3 Series</sup>





- **Regenerative Resistor**

- For selecting a regenerative resistor, please refer to ASDA-A3 User Manual, Chapter 2.8 Selecting Regenerative Resistor



- **USB Communication Cables (for PC)**

- USB Communication Cables (for PC)
- USB1.1 is equipped as standard



- **CANopen Accessories**

- Connect to Delta PLC CAN Master with TAP-CN03 distribution box
- CANopen communication cable is provided

# Product Information

## ASDA-Soft Configuration Software



### Auto-Tuning Function

- Step-to-step guide on using the auto tuning function
- Flow chart of the setting procedure and tuning progress
- Compare the tuning results (before & after)
- Downloadable gain parameters

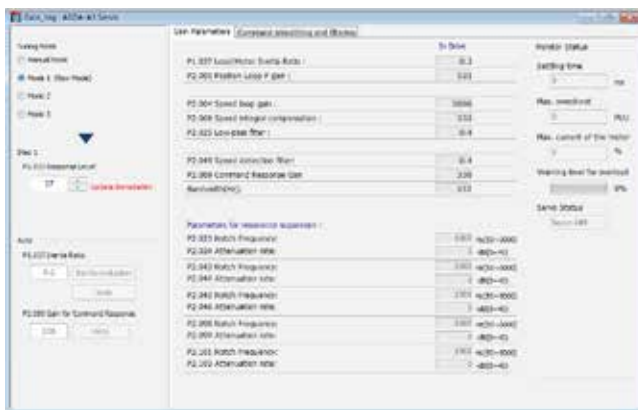

### Advanced Tuning Function

- Four tuning modes available
- Manual mode: All gains tuned manually, which is for those who has profound knowledge of servo gain adjustment
- Mode 1: For fine-tuning the bandwidth
- Mode 2: For fine-tuning the inertia and bandwidth
- Mode 3: For fine-tuning the inertia, bandwidth and command responsiveness

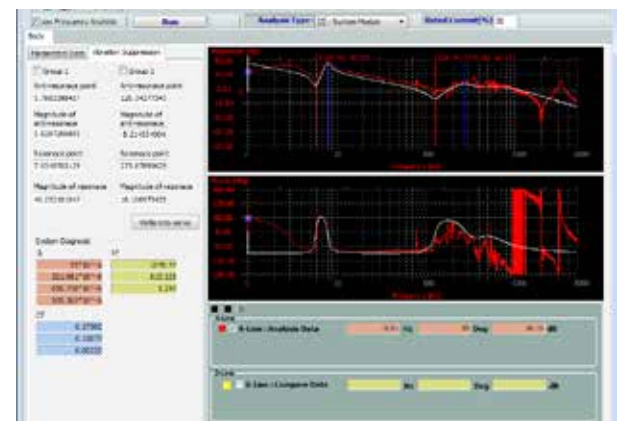

### System Module and Low Frequency Analysis

- Provide analysis on rigidity of the system
- Acquire the low-frequency resonance data and automatically set the relevant parameters to eliminate the vibration with just one click
- Collect data such as inertia, elasticity and viscous friction coefficient for knowing the mechanism's features and wear condition

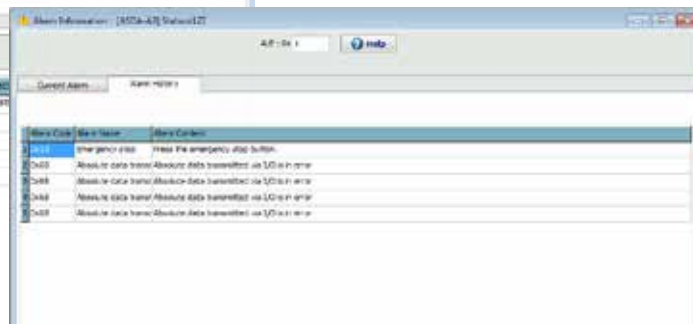
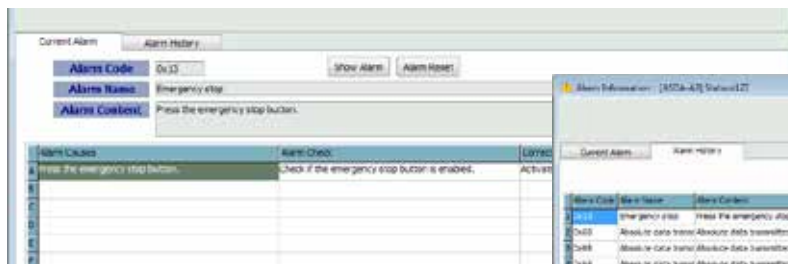

### Alarm Information

- Display current alarm and alarm log
- Provide simple corrective actions for quick troubleshooting

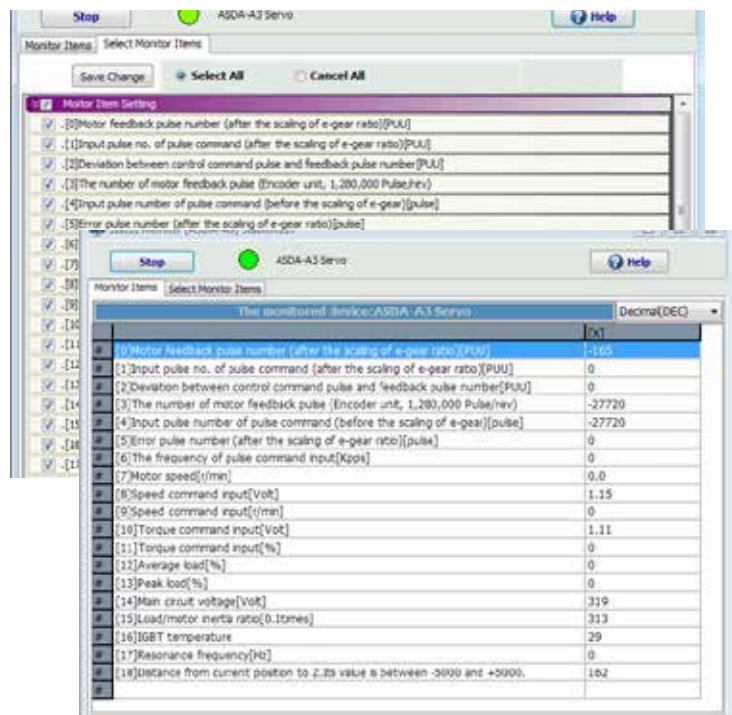

### Condition Monitoring

- Real-time display of servo motor operation status via the monitoring list

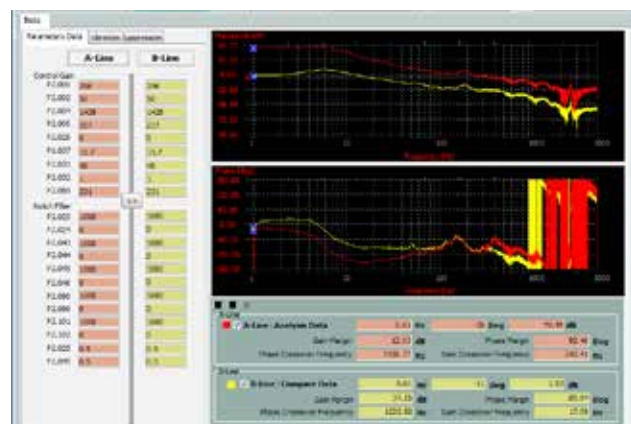

### Speed Open-Loop Mode

- Acquire the gain condition for optimizing the equipment performance
- Check the system stability via monitoring the gain and phase margins



## Product Information

### Servo Motor Features

The ECM-A3 Series AC Servo Motor is a high-precision permanent magnet AC servo motor. It can be used with the ASDA-A3 AC Servo Drives of 200 ~ 230V with power ranging from 50W ~ 750W. Motor frame sizes offer 40 mm, 60 mm and 80 mm. Two motor models are available, the ECM-A3H high inertia and the ECM-A3L low inertia which rated speed is 3000 r/min and the Max. speed is 6000 r/min. The max. torque of the ECM-A3H is 0.557 N-m ~ 8.36 N-m and that of ECM-A3L is 0.557 N-m ~ 8.36 N-m.

The high precision permanent magnet AC servo motor ECMC Series can also be applied with the ASDA-A3 220 V Series AC Servo Drive with power range from 850W ~ 3kW. The available frame sizes are 100 mm, 130 mm, and 180 mm. Selectable rated torque are 1000 r/min, 2000 r/min, and 3000 r/min while the max. speed is 3000 r/min and 5000 r/min. And the max. torque is from 9.54 N-m to 57.3 N-m.

The ECM-A3 and the ECMC Series AC Servo Motors provide optional devices, brakes and oil seals, as well as two shaft types: round shaft and keyway.





# Ordering Information

## Product Line Up

Servo Motors							Servo Drives		
Motor Series	Phase	Rated Output Power (W)	Model Name	Rated current (Arms)	Max. current (Arms)	Model Name	Continuous Output Current (Arms)	Max. Instantaneous Current (Arms)	
Low Inertia	ECM-A3L 3000 r/min	1-phase / 3-phase	50	ECM-A3L-C <sup>1</sup> 040F <sup>2</sup> S1	0.66	2.82	ASD-A3-0121	0.9	3.54
			100	ECM-A3L-C <sup>1</sup> 0401 <sup>2</sup> S1	0.9	3.88			
			200	ECM-A3L-C <sup>1</sup> 0602 <sup>2</sup> S1	1.45	6.2	ASD-A3-0221	1.55	7.07
			400	ECM-A3L-C <sup>1</sup> 0604 <sup>2</sup> S1	2.65	10.1	ASD-A3-0421	2.6	10.61
			400	ECM-A3L-C <sup>1</sup> 0804 <sup>2</sup> 71	2.6	10.6			
			750	ECM-A3L-C <sup>1</sup> 0807 <sup>2</sup> S1	5.1	20.6	ASD-A3-0721	5.1	21.21
Medium-High Inertia	ECMC-C 3000 r/min	1-phase / 3-phase	1000	ECMC-CW1010 <sup>2</sup> S	7.3	21.9	ASD-A3-1021	7.3	24.75
	ECMC-E 2000 r/min		1-phase / 3-phase	1000	ECMC-EW1310 <sup>2</sup> S	5.6			
		1500		ECMC-EW1315 <sup>2</sup> S	8.3	24.9	ASD-A3-2023	13.4	53.03
		2000		ECMC-EW1320 <sup>2</sup> S	11.01	33.0			
		2000		ECMC-EW1820 <sup>2</sup> S	11.22	33.7			
	3000	ECMC-EW1830 <sup>2</sup> S	16.1	48.3	ASD-A3-3023	19.4	70.71		
ECMC-F 1500 r/min	3-phase	3000	ECMC-FW1830 <sup>2</sup> S	19.4				58.2	
High Inertia	ECM-A3H 3000 r/min	1-phase / 3-phase	50	ECM-A3H-C <sup>1</sup> 040F <sup>2</sup> S1	0.64	2.59	ASD-A3-0121	0.9	3.54
			100	ECM-A3H-C <sup>1</sup> 0401 <sup>2</sup> S1	0.9	3.64			
			200	ECM-A3H-C <sup>1</sup> 0602 <sup>2</sup> S1	1.45	5.3	ASD-A3-0221	1.55	7.07
			400	ECM-A3H-C <sup>1</sup> 0604 <sup>2</sup> S1	2.65	9.8	ASD-A3-0421	2.6	10.61
			400	ECM-A3H-C <sup>1</sup> 0804 <sup>2</sup> 71	2.6	9.32			
			750	ECM-A3H-C <sup>1</sup> 0807 <sup>2</sup> S1	4.61	16.53	ASD-A3-0721	5.1	21.21
	ECMC-F 1500 r/min	1-phase / 3-phase	850	ECMC-FW1308 <sup>2</sup> S	7.1	19.4	ASD-A3-1021	7.3	24.75
			1300	ECMC-FW1313 <sup>2</sup> S	12.6	38.6	ASD-A3-2023	13.4	53.03
			1800	ECMC-FW1318 <sup>2</sup> S	13	36	ASD-A3-2023	13.4	53.03

Note: In servo motor model names, <sup>1</sup> signifies encoder type, <sup>2</sup> signifies brake or keyway/oil seal.

# Ordering Information

## Model Name Explanation

### ASDA-A3 Series Servo Drives

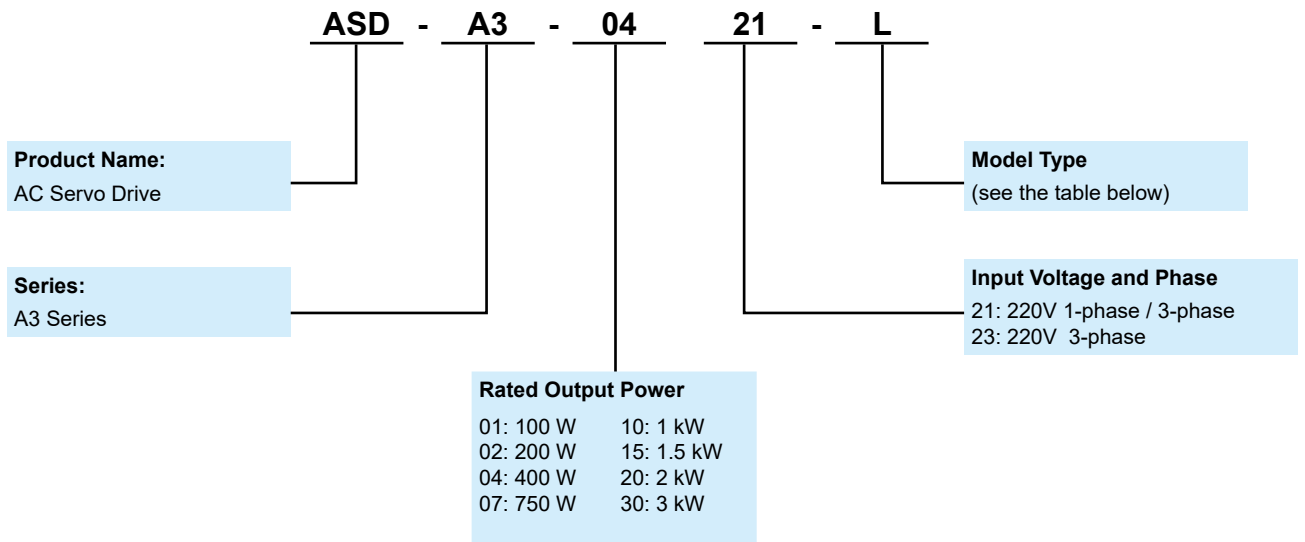



Type	PT Mode Pulse Train	PR Mode	RS-485	CANopen	DMCNET	EtherCAT	Full- closed Loop Control	Analog Voltage Control	E-CAM	STO
L	○	○	○	X	X	X	○	○	X	X
M	○	○	○	○	X	X	○	○	○	○
F	X	○	X	X	○	X	○	X	○	X
E*	X	○	X	X	X	○	○	X	○	○

Note: Models with a \* mark are the ones to be launched.



# Servo Drive Specifications

ASDA-A3		100 W	200 W	400 W	750 W	1 kW	1.5 kW	2 kW	3 kW	
		01	02	04	07	10	15	20	30	
Power supply	Phase / Voltage	Single-phase / three-phase 220 VAC						Three-phase 220 VAC		
	Permissible Voltage Range	Single-phase / three-phase 200~230 VAC, -15%~10%						Three-phase 200~230 VAC, -15%~10%		
	Input Current(3PH) (Units: Arms)	0.67	1.34	2.67	5.01	6.68	10.02	13.36	20.05	
	Input Current(1PH) (Units: Arms)	1.16	2.31	4.63	8.68	11.57	17.36	-	-	
	Continuous Output Current (Units: Arms)	0.9	1.55	2.65	5.1	7.3	12.6	13.4	19.4	
Instantaneous Maximum Output Current (Units: Arms)		3.54	7.07	10.61	21.21	24.75	35.36	53.03	70.71	
Cooling System		Natural Air Circulation			Fan Cooling					
Drive resolution		24-bit (16777216 p/rev)								
Control of Main Circuit		SVPWM Control								
Tuning Modes		Auto / Manual								
Regenerative Resistor		None			Built-in					
Position Control Mode	Pulse Type (Only for Non-DMCNET mode)		Pulse + Direction, A phase + B + CW pulse							
	Max. Input Pulse Frequency (Only for Non-DMCNET mode)		Pulse + Direction: 4Mpps ; CCW pulse + CW pulse: 4Mpps ; A phase + B phase: Single phase 4Mpps ; Max. 200Kpps (Open collector)p/s							
	Command Source		External pulse train (PT mode) (Only for Non-DMCNET mode) / Internal parameters (PR mode)							
	Smoothing Strategy		Low-pass and P-curve filter							
	Electronic Gear		Electronic gear N/M multiple N: 1~536870911, M: 1~2147483647 (1/4 < N/M < 262144)							
	Torque Limit Operation		Set by parameters							
	Feed Forward Compensation		Set by parameters							
Speed Control Mode	Analog Input Command (Only for Non-DMCNET mode)	Voltage Range	0 ~ ±10 V <sub>DC</sub>							
		Resolution	15-bit							
	Input Resistance	Input Resistance	1MΩ							
		Time Constant	25 μs							
	Speed Control Range <sup>*1</sup>		1 : 6000							
	Command Source		External analog signal (Only for Non-DMCNET mode) / Internal parameters							
	Smoothing Strategy		Low-pass and S-curve filter							
Torque Limit Operation		Set by parameters or analog input (Only for Non-DMCNET mode)								
Frequency Response Characteristic		Maximum 3.1kHz								
Speed Accuracy <sup>*2</sup>		0.01% or less at 0 to 100% load fluctuation								
		0.01% or less at ±10% power fluctuation								
		0.01% or less at 0°C to 50°C ambient temperature fluctuation								
Torque Control Mode	Analog Input Command (Only for Non-DMCNET mode)	Voltage Range	0 ~ ±10 V <sub>DC</sub>							
		Input Resistance	1MΩ							
	Time Constant	Input Resistance	1MΩ							
		Time Constant	25 μs							
Command Source		External analog signal (Only for Non-DMCNET mode) / Internal parameters								
Smoothing Strategy		Low-pass filter								
Speed Limit		Set by parameters or analog input (Only for Non-DMCNET mode)								
Analog Monitor Output		Monitor signal can set by parameters (Output voltage range: ±8V)								
Digital Inputs / Outputs	Inputs	Servo on, Reset, Gain switching, Pulse clear, Zero speed CLAMP, Command input reverse control, Command triggered, Speed / Torque limit enabled, Position command selection, Motor stop, Speed position selection, Position / Speed mode switching, Speed / Torque mode switching, Torque / Position mode switching, PT / PR command switching, Emergency stop, Forward / Reverse inhibit limit, Reference "Home" sensor, Forward / Reverse operation torque limit, Move to "Home", Electronic Cam (E-Cam), Forward / Reverse JOG input, Event trigger PR command, Electronic gear ratio (Numerator) selection and Pulse inhibit input  * Please note that the above digital signals and inputs are available only for Non-DMCNET mode. In DMCNET mode, it is recommended to write digital inputs into the servo drives through DMCNET communication, and the digital inputs should be used for Emergency Stop, Forward / Reverse Inhibit limit and Reference "Home" sensor only.								
	Outputs	Encoder signal output (A, B, Z Line Driver and Z Open Collector)  Servo ready, Servo on, At Zero speed, At Speed reached, At Positioning completed, At Torques limit, Servo alarm (Servo fault) activated, Electromagnetic brake control, Homing completed, Output overload warning, Servo warning activated, Position command overflow, Forward / Reverse software limit, Internal position command completed, Capture operation completed output., Motion control completed output., Master position of E-Cam (Electronic Cam)								
Protective Functions		Overcurrent, Overvoltage, Undervoltage, Motor overheated, Regeneration error, Overload, Overspeed, Abnormal pulse control command, Excessive deviation, Encoder error, Adjustment error, Emergency stop activated, Reverse/ Forward limit switch error, Position excessive deviation of full-close control loop, Serial communication error, Input power phase loss, Serial communication time out, short circuit protection of U, V, W, and CN1, CN2, CN3 terminals								
Communication Interface		RS-485 / CANopen / USB								
Environment	Installation Site		Indoor environment (free of direct sunlight), no corrosive liquid and gas (free of oil mist, flammable gas, or dust)							
	Altitude		Altitude 2000m or lower above sea level							
	Atmospheric Pressure		86kPa ~ 106kPa							
	Operating Temperature		0°C ~ 55°C (If operating temperature is above 45°C, forced cooling will be required)							
	Storage Temperature		-20 °C ~ 65 °C							
	Humidity		0 ~ 90% RH (non-condensing)							
	Vibration		9.80665 m/s <sup>2</sup> (1G) less than 20Hz, 5.88 m/s <sup>2</sup> (0.6G) 20 to 50Hz							
	IP Rating		IP20							
Power System		TN System <sup>*3,4</sup>								
Approvals		IEC/EN 61800-5-1, UL 61800-5-1,  								

Note: \*1. When it is with the rated load, the speed ratio is: the minimum speed (smooth operation) / rated speed.

\*2. When the command is the rated speed, the velocity correction ratio is: (free run speed - full load speed) / rated speed

\*3. TN system: The neutral point of the power system connects to the ground directly. The exposed metal components connect to the ground via the protective earth conductor.

\*4. Use a single-phase three-wire power systems for models of single-phase power

# Ordering Information

## Servo Drive Dimensions

### Frame A

100W / 200W

**Weight**  
0.84 kg

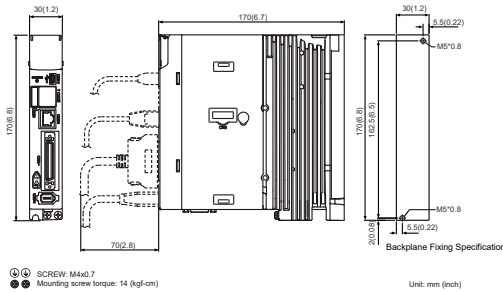

-L

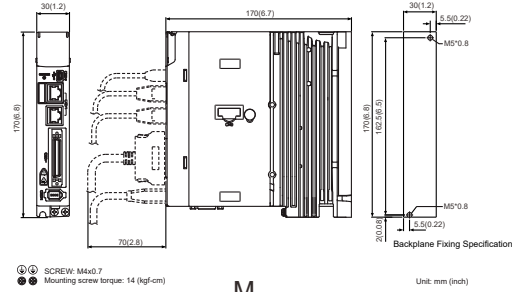

-M

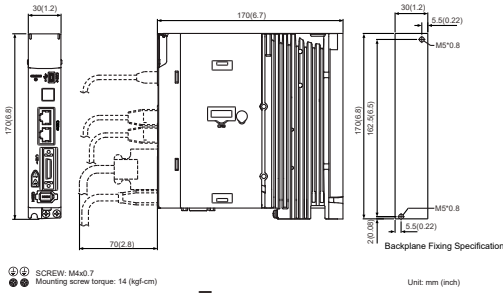

-F

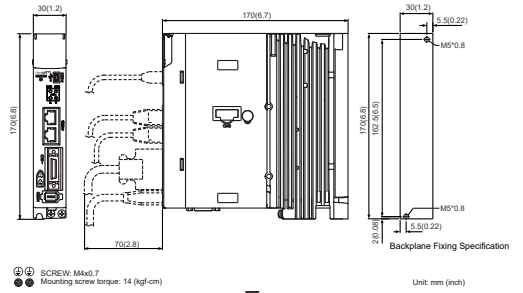

-E

### Frame B

400W

**Weight**  
0.92kg

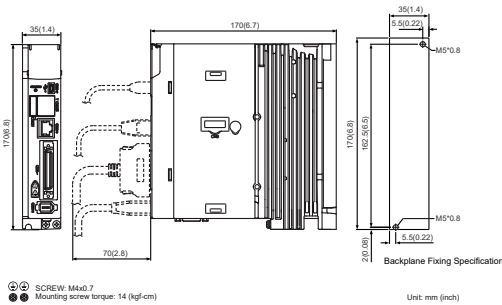

-L

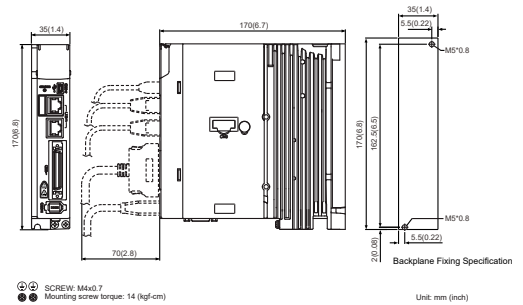

-M

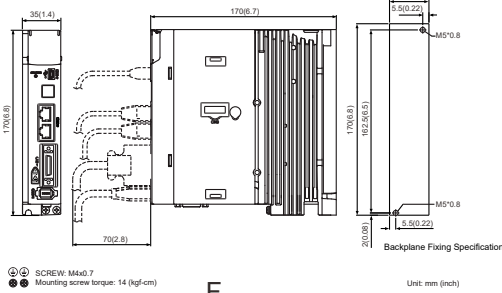

-F

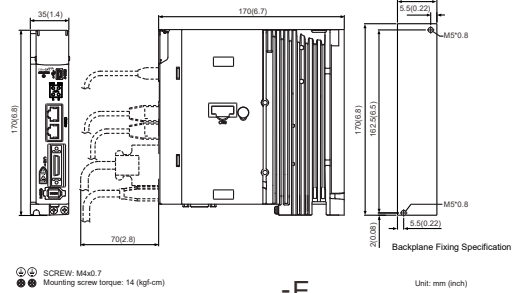

-E

**Note:**

1. Dimensions are in millimeters (inches); Weights are in kilograms (kg) and pounds (lbs).
2. Dimensions and weights of the servo drive may be revised without prior notice.

## Frame C

750 W / 1 kW / 1.5 kW

**Weight**  
1.3kg

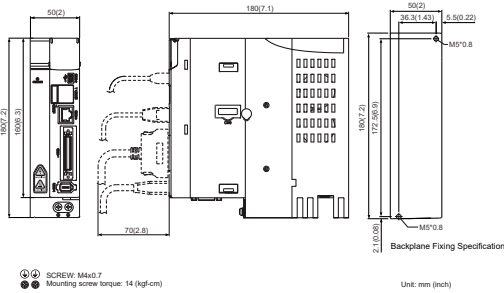

-L

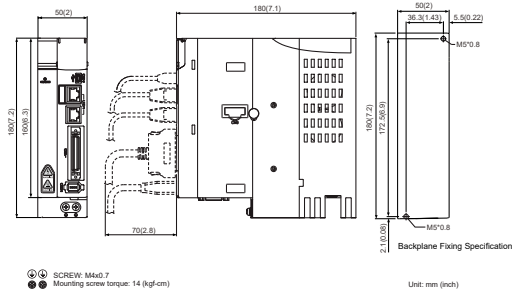

-M

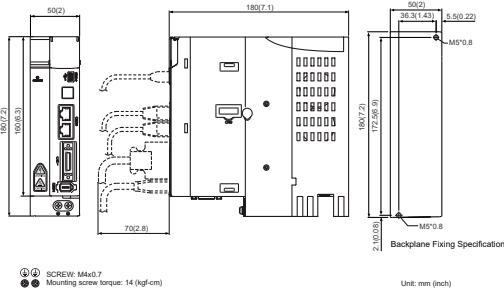

-F

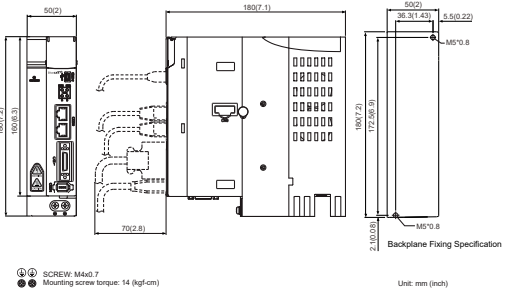

-E

2 kW / 3 kW

**Weight**  
2.7kg

## Frame D

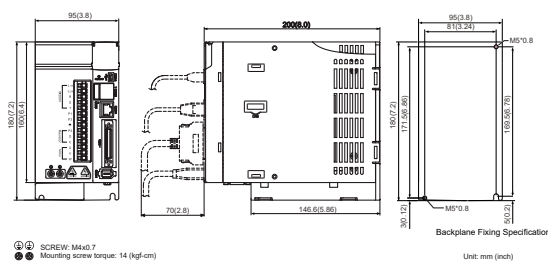

-L

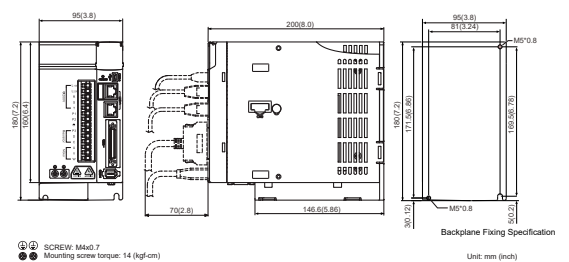

-M

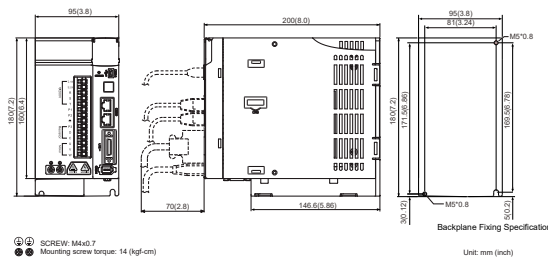

-F

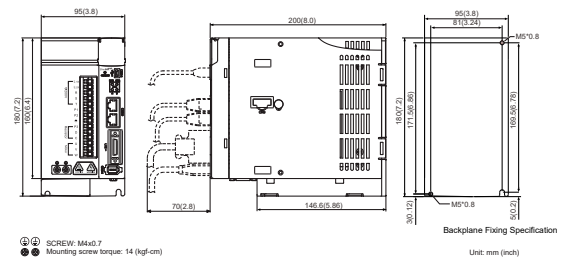

-E

Note:

1. Dimensions are in millimeters (inches); Weights are in kilograms (kg) and pounds (lbs).
2. Dimensions and weights of the servo drive may be revised without prior notice.



# Ordering Information

## Model Name Explanation

### ECM-A3 Series Servo Motors

ECM - A 3 H - C Y 06 04 R S 1

**Product Name**  
ECM: Electrical  
Commutation Motor

**Driving Type**  
A: A Series

**Generation**  
3: 3rd Generation

**Inertia**  
H: High inertia  
L: Low inertia

**Series Rated Voltage / Rated Speed**  
C: Rated Voltage 220 V  
Rated Speed 3,000 r/min

**Encoder Type**  
Y: 24-bit Absolute Optical Encoder  
Single-turn: 24-bit  
Multi-turn: 16-bit  
1: 24-bit Single-turn Absolute Optical Encoder  
G: 16-bit Single-turn Absolute Magnetic Encoder  
2: 24-bit Single-turn Absolute Magnetic Optical Encoder  
A: 24-bit Absolute Magnetic Optical Encoder  
Single-turn: 24-bit  
Multi-turn: 16-bit

**Motor Frame Size**  
04: 40 mm  
06: 60 mm  
08: 80 mm

**Special digit**  
1: standard product

**Shaft size**  
S: Standard  
7: special (14 mm)

Shaft and Oil Seal	W/O Brake W/O Oil Seal	With Brake W/O Oil Seal	W/O Brake With Oil Seal	With Brake With Oil Seal
Round Shaft (with screw hole)	-	-	C	D
Keyway (with screw hole)	P	Q	R	S

**Rated Output Power**  
0F: 50 W  
01: 100 W  
02: 200 W  
04: 400 W  
07: 750 W

\*To be launched



# Servo Motor Specifications

## Low Inertia Series- ECM-A3L

ECM-A3L Series	C104		C106		C108	
	0F	01	02	04	04	07
Rated output power (kW)	0.05	0.1	0.2	0.4	0.4	0.75
Rated torque (N-m) <sup>*1</sup>	0.159	0.32	0.64	1.27	1.27	2.39
Maximum torque (N-m)	0.557	1.12	2.24	4.45	4.44	8.36
Rated speed (r/min)	3000					
Maximum speed (r/min)	6000					
Rated current (Arms)	0.66	0.9	1.45	2.65	2.6	5.1
Maximum current (Arms)	2.82	3.88	6.2	10.1	10.6	20.6
Power rating (kW/s)	11	25.6	45.5	107.5	45.8	102.2
Rotor moment of inertia (x10 <sup>-4</sup> kg-m <sup>2</sup> )(Without brake)	0.0229	0.04	0.09	0.15	0.352	0.559
Mechanical time constant (ms)	1.28	0.838	0.64	0.41	0.68	0.44
Torque constant (N-m/A)	0.241	0.356	0.441	0.479	0.488	0.469
Voltage constant-KE (mV/(r/min))	9.28	13.3	16.4	18.0	17.9	17
Armature resistance (Ohm)	12.1	9.47	4.9	2.27	1.6	0.6
Armature inductance (mH)	18.6	16.2	18.52	10.27	10.6	4.6
Electrical time constant (ms)	1.54	1.71	3.78	4.52	6.63	7.67
Insulation class	Class A (UL), Class B (CE)					
Insulation resistance	100 MΩ, DC 500V above					
Insulation strength	1.8k Vac, 1 sec					
Weight (kg)(without brake)	0.38	0.5	1.1	1.4	2.05	2.8
Weight (kg)(with brake)	0.68	0.8	1.6	1.9	2.85	3.6
Max. radial shaft load (N)	78	78	245	245	392	392
Max. thrust shaft load (N)	54	54	74	74	147	147
Power rating (kW/s)(with brake)	9.9	24	34.1	89.6	39.5	93
Rotor moment of inertia (x10 <sup>-4</sup> kg-m <sup>2</sup> )(with brake)	0.0255	0.0426	0.12	0.18	0.408	0.614
Mechanical time constant (ms)(with brake)	1.44	0.892	0.85	0.5	0.78	0.48
Brake holding torque [N·m (min)] <sup>2</sup>	0.32	0.32	1.3	1.3	2.5	2.5
Brake power consumption (at 20°C)[W]	6.1	6.1	7.2	7.2	8	8
Brake release time [ms (Max)]	20	20	20	20	20	20
Brake pull-in time [ms (Max)]	35	35	50	50	60	60
Vibration grade (μm)	V15					
Operating temperature (°C)	0°C ~ 40°C					
Storage temperature (°C)	-10°C ~ 80°C					
Operating humidity	20 to 90%RH (non-condensing)					
Storage humidity	20 to 90%RH (non-condensing)					
Vibration capacity	2.5G					
IP Rating	IP65 (when waterproof connectors are used, or when an oil seal is used to be fitted to the rotating shaft)					
Approvals	CE					

Note:  
 1. The rated torque is the permissible continuous torque at the operation temperature of 0~40°C when the following heat sink is applied:  
 ECM-A3: \_04/06/ 08 : 250 mm x 250mm x 6mm  
 Material type: Aluminum- F40, F60, F80  
 2. The built-in brake of the servo motor is for calmping the shaft. Never use it for decelerating or stopping the motor

# Ordering Information

## Servo Motor Specifications

### High Inertia Series- ECM-A3H

ECM-A3H Series	C104		C106		C108	
	0F	01	02	04	04	07
Rated output power (kW)	0.05	0.1	0.2	0.4	0.4	0.75
Rated torque (N-m) <sup>1</sup>	0.159	0.32	0.64	1.27	1.27	2.39
Maximum torque (N-m)	0.557	1.12	2.24	4.45	4.44	8.36
Rated speed (r/min)	3000					
Maximum speed (r/min)	6000					
Rated current (A rms)	0.64	0.9	1.45	2.65	2.6	4.61
Maximum current (A rms)	2.59	3.64	5.4	9.8	9.32	16.53
Power rating (kW/s)	5.56	13.6	16.4	35.8	17.5	37.8
Rotor moment of inertia (x10 <sup>-4</sup> kg-m <sup>2</sup> )(Without brake)	0.0455	0.0754	0.25	0.45	0.92	1.51
Mechanical time constant (ms)	2.52	1.43	1.38	0.96	1.32	0.93
Torque constant (N-m/A)	0.248	0.356	0.441	0.479	0.49	0.52
Voltage constant-KE (mV/(r/min))	9.54	12.9	16.4	17.2	17.9	18.7
Armature resistance (Ohm)	12.5	8.34	3.8	1.68	1.19	0.57
Armature inductance (mH)	13.34	11	8.15	4.03	4.2	2.2
Electrical time constant (ms)	1.07	1.32	2.14	2.40	3.53	3.86
Insulation class	Class A (UL), Class B (CE)					
Insulation resistance	100 MΩ, DC 500 V above					
Insulation strength	1.8k Vac, 1 sec					
Weight (kg)(without brake)	0.38	0.5	1.1	1.4	2.05	2.8
Weight (kg)(with brake)	0.68	0.8	1.6	1.9	2.85	3.6
Max. radial shaft load (N)	78	78	245	245	392	392
Max. thrust shaft load (N)	54	54	74	74	147	147
Power rating (kW/s)(with brake)	4.89	12.5	14.6	33.6	15.07	34.41
Rotor moment of inertia (x10 <sup>-4</sup> kg-m <sup>2</sup> )(with brake)	0.0517	0.0816	0.28	0.48	1.07	1.66
Mechanical time constant (ms)(with brake)	2.86	1.55	1.54	1.02	1.54	1.02
Brake holding torque [Nt-m (min)] <sup>2</sup>	0.32	0.32	1.3	1.3	2.5	2.5
Brake power consumption (at 20°C)[W]	6.1	6.1	7.2	7.2	8	8
Brake release time [ms (Max)]	20	20	20	20	20	20
Brake pull-in time [ms (Max)]	35	35	50	50	60	60
Vibration grade (μm)	V15					
Operating temperature (°C)	0°C ~ 40°C					
Storage temperature (°C)	-10°C ~ 80°C					
Operating humidity	20 to 90%RH (non-condensing)					
Storage humidity	20 to 90%RH (non-condensing)					
Vibration capacity	2.5G					
IP Rating	IP65 (when waterproof connectors are used, or when an oil seal is used to be fitted to the rotating shaft)					
Approvals						

**Note:**

1. The rated torque is the permissible continuous torque at the operation temperature of 0~40°C when the following heat sink is applied:

ECM-A3: 04/06/ 08 : 250 mm x 250mm x 6mm

Material type: Aluminum- F40, F60, F80

2. The built-in brake of the servo motor is for calamping the shaft. Never use it for decelerating or stopping the motor

# Servo Motor Dimensions

## ECM-A3 Series

### Frame Size 80 mm and Below

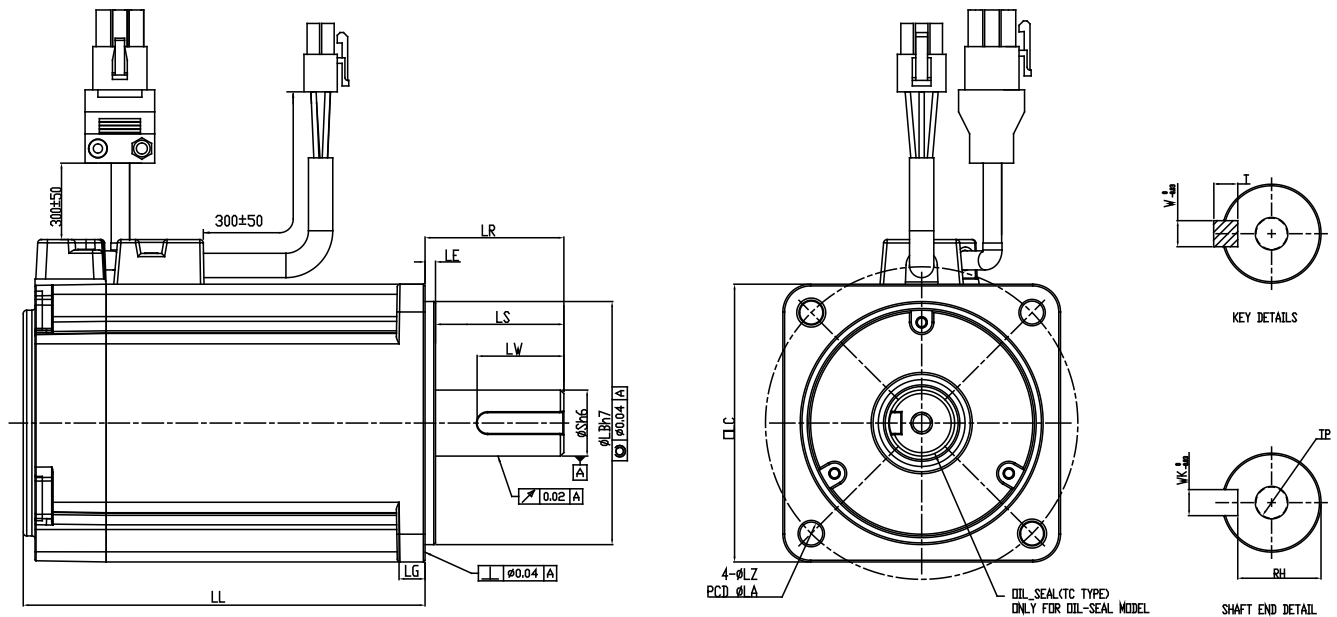

Units: mm

Model	C 1 040F 2 S 3 <sup>*1</sup>	C 1 0401 2 S 3	C 1 0602 2 S 3	C 1 0604 2 S 3	C 1 0804 2 7 3	C 1 0807 2 S 3 <sup>*2</sup>
LC	40	40	60	60	80	80
LZ	4.5	4.5	5.5	5.5	6.6	6.6
LA	46	46	70	70	90	90
S	8 ( <sup>+0</sup> / <sub>0.009</sub> )	8 ( <sup>+0</sup> / <sub>0.009</sub> )	14 ( <sup>+0</sup> / <sub>0.011</sub> )	14 ( <sup>+0</sup> / <sub>0.011</sub> )	14 ( <sup>+0</sup> / <sub>0.011</sub> )	19 ( <sup>+0</sup> / <sub>0.013</sub> )
LB	30 ( <sup>+0</sup> / <sub>0.021</sub> )	30 ( <sup>+0</sup> / <sub>0.021</sub> )	50 ( <sup>+0</sup> / <sub>0.025</sub> )	50 ( <sup>+0</sup> / <sub>0.025</sub> )	70 ( <sup>+0</sup> / <sub>0.03</sub> )	70 ( <sup>+0</sup> / <sub>0.03</sub> )
LL(without brake)	70.6	85.3	84	106	93.7	115.8
LL(with brake)	105.4	120.1	117.6	139.7	131.2	153.2
LS	21.5	22.5	27	27	27	37
LR	25	25	30	30	30	40
LE	2.5	2.5	3	3	3	3
LG	5	5	7.5	7.5	8	8
LW	16	16	20	20	20	25
RH	6.2	6.2	11	11	11	15.5
WK	3	3	5	5	5	6
W	3	3	5	5	5	6
T	3	3	5	5	5	6
TP	M3 Depth 6	M3 Depth 6	M4 Depth 8	M4 Depth 8	M4 Depth 8	M6 Depth 10

Note:  
<sup>\*1</sup> In servo motor model names, [1] signifies encoder type, [2] signifies shaft diameter and oil seal, and [3] signifies special code  
<sup>\*2</sup> When [3] of Model 807 is Z, LS=32, LR=35

# Ordering Information

## Speed-Torque Curves (T-N Curves)

### ECM-A3 Torque Features

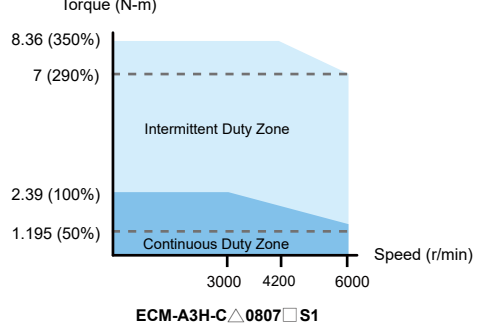
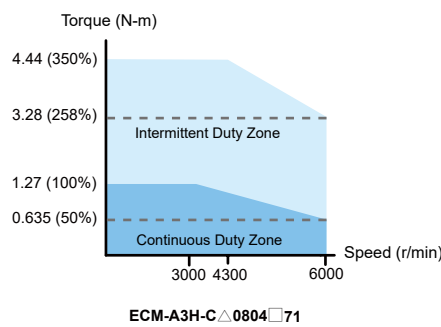
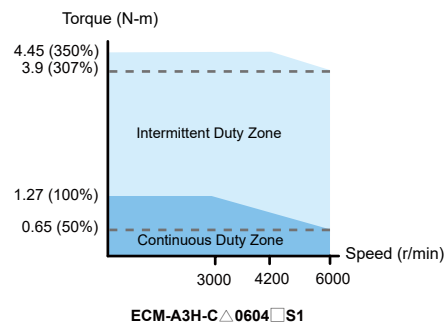
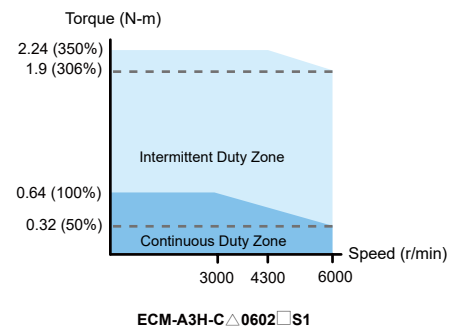
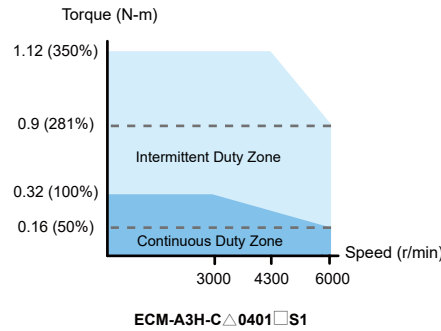
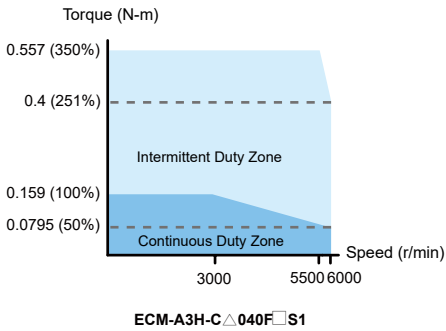
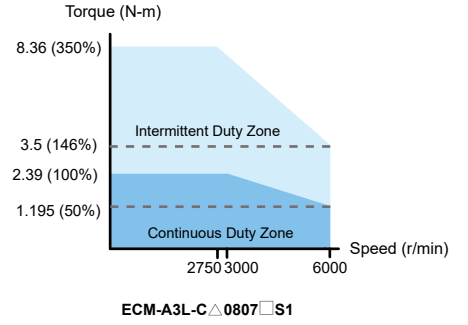
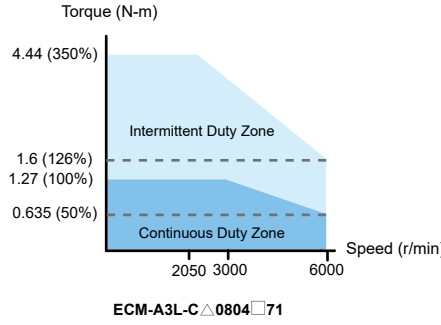
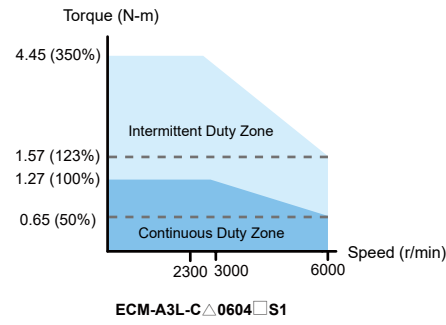
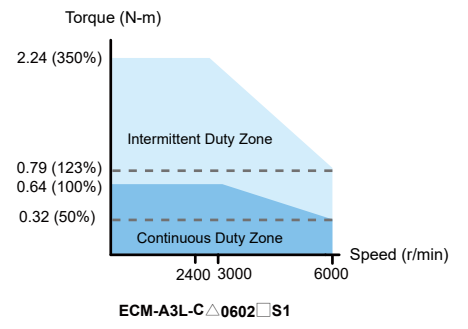
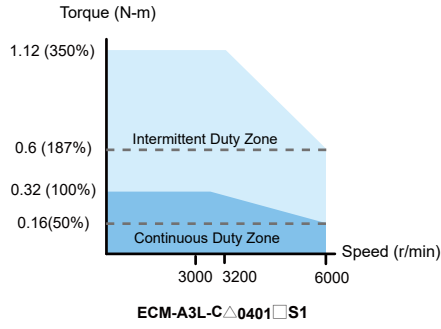
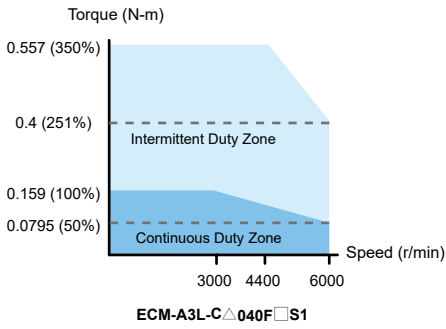



# Model Name Explanation

## ECMC Series Servo Motors

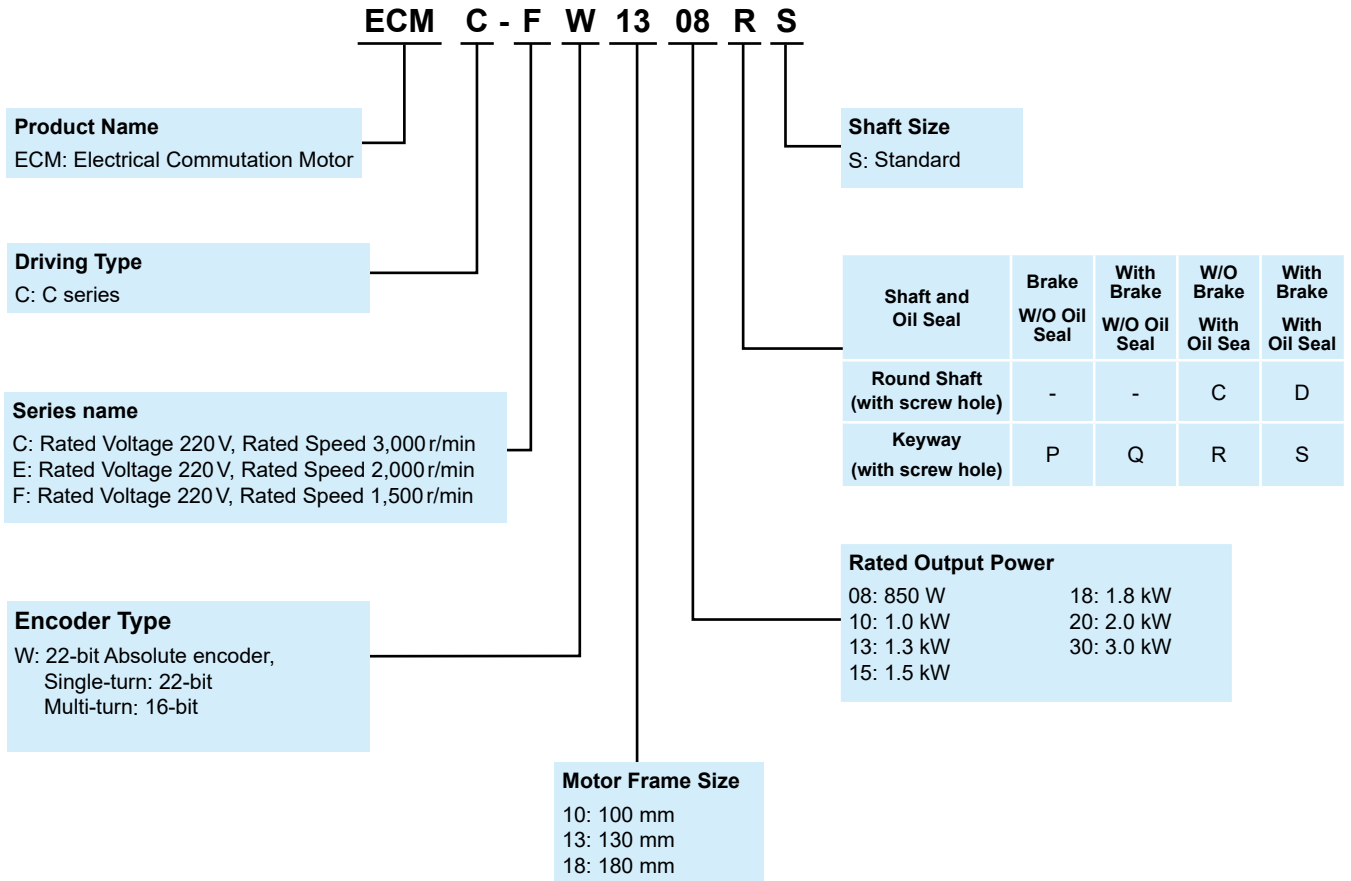

# Ordering Information

## Servo Motor Specifications

### Medium Inertia ECMC Series - Frame Sizes 100~180 mm

ECMC Series	C10	E13			E18		F18	
	10	10	15	20	20	30	30	
Rated output power (kW)	1.0	1.0	1.5	2.0	2.0	3.0	3.0	
Rated torque (N-m) <sup>1</sup>	3.18	4.77	7.16	9.55	9.55	14.32	19.10	
Maximum torque (N-m)	9.54	14.3	21.5	28.7	28.7	43	57.3	
Rated speed (r/min)	3000	2000			2000		1500	
Maximum speed (r/min)	5000	3000			3000		3000	
Rated current (Arms)	7.3	5.6	8.3	11.01	11.2	16.1	19.4	
Maximum current (Arms)	21.9	16.8	24.9	33	33.7	48.3	58.2	
Power rating (kW/s)	38.1	27.1	45.9	62.5	26.3	37.3	66.4	
Rotor moment of inertia (x10 <sup>-4</sup> kg-m <sup>2</sup> )(Without brake)	2.65	8.41	11.2	14.6	34.7	55	55	
Mechanical time constant (ms)	0.74	1.51	1.10	0.96	1.62	1.06	1.28	
Torque constant (N-m/A)	0.44	0.85	0.87	0.87	0.85	0.89	0.98	
Voltage constant-KE (mV/(r/min))	16.8	31.9	31.8	31.8	31.4	32.0	35	
Armature resistance (Ohm)	0.20	0.47	0.26	0.174	0.119	0.052	0.077	
Armature inductance (mH)	1.81	5.99	4.01	2.76	2.84	1.38	1.27	
Electrical time constant (ms)	9.3	12.9	15.3	15.9	23.9	26.4	16.5	
Insulation class	Class A (UL), Class B (CE)							
Insulation resistance	100 MΩ, DC 500V above							
Insulation strength	1.8k Vac, 1 sec							
Weight (kg)(without brake)	4.3	7.0	7.5	7.8	13.5	18.5	18.5	
Weight (kg)(with brake)	4.7	8.4	8.9	9.2	17.5	22.5	22.5	
Max. radial shaft load (N)	490				1176	1470		
Max. thrust shaft load (N)	98				490			
Power rating (kW/s)(with brake)	30.4	24.9	43.1	57.4	24.1	35.9	63.9	
Rotor moment of inertia (x10 <sup>-4</sup> kg-m <sup>2</sup> )(with brake)	3.33	9.14	11.9	15.9	37.8	57.1	57.1	
Mechanical time constant (ms)(with brake)	0.93	1.64	1.19	1.05	1.77	1.10	1.33	
Brake holding torque [Nt-m (min)] <sup>2</sup>	8	10			25			
Brake power consumption (at 20°C)[W]	18.7	19			20.4			
Brake release time [ms (Max)]	10							
Brake pull-in time [ms (Max)]	70							
Vibration grade (μm)	V15							
Operating temperature (°C)	0°C ~ 40°C (32°F ~ 104°F)							
Storage temperature (°C)	-10°C ~ 80°C (-14°F ~ 176°F)							
Operating humidity	20 to 90%RH (non-condensing)							
Storage humidity	20 to 90%RH (non-condensing)							
Vibration capacity	2.5G							
IP Rating	IP65 (when waterproof connectors are used, or when an oil seal is used to be fitted to the rotating shaft)							
Approvals								

Note:

1. □ in the servo model name signifies encoder type.

2. The rated torque is the permissible continuous torque at the operation temperature of 0~40°C when the following heat sink is applied:

ECMC- 10 : 300 mm x 300 mm x 12 mm

ECMC- 13 : 400 mm x 400 mm x 20 mm

ECMC- 18 : 550 mm x 550 mm x 30 mm

Material type: Aluminum- F100, F130, F180

3. The built-in brake of the servo motor is for calmping the shaft. Never use it for decelerating or stopping the motor

## Servo Motor Dimensions

### ECMC Series

### Frame Sizes 100 / 130 mm

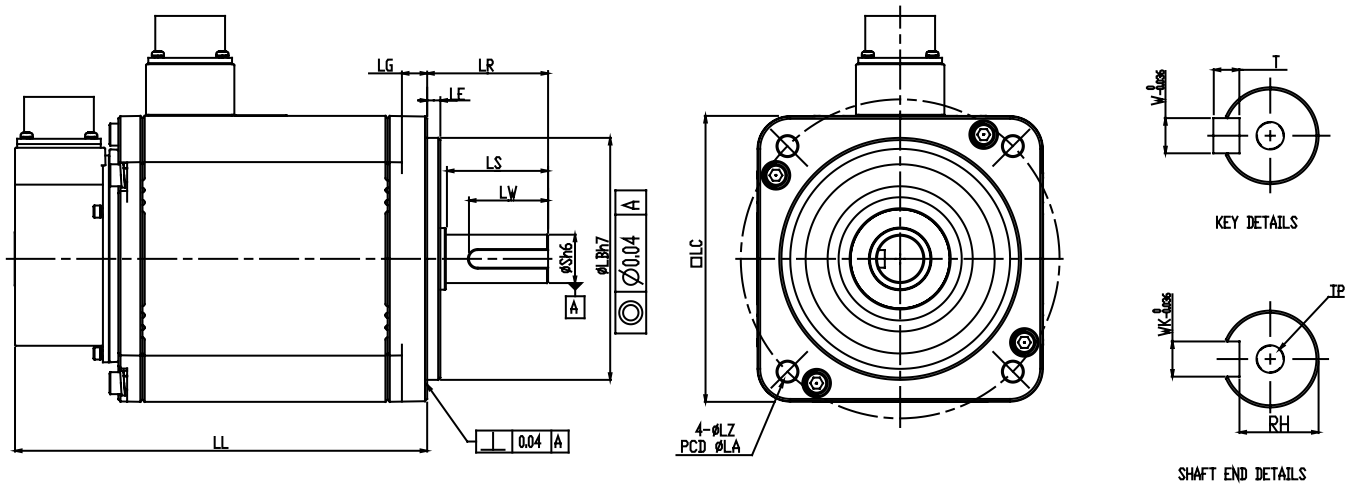

Units: mm

Model	C □ 1010 □ S <sup>*1</sup>	E □ 1310 □ S	E □ 1315 □ S	E □ 1320 □ S	F □ 1308 □ S	F □ 1313 □ S	F □ 1318 □ S
LC	100	130	130	130	130	130	130
LZ	9	9	9	9	9	9	9
LA	115	145	145	145	145	145	145
S	22 ( $^{+0}_{-0.013}$ )	22 ( $^{+0}_{-0.013}$ )	22 ( $^{+0}_{-0.013}$ )	22 ( $^{+0}_{-0.013}$ )	22 ( $^{+0}_{-0.013}$ )	22 ( $^{+0}_{-0.013}$ )	22 ( $^{+0}_{-0.013}$ )
LB	95 ( $^{+0}_{-0.035}$ )	110 ( $^{+0}_{-0.035}$ )	110 ( $^{+0}_{-0.035}$ )	110 ( $^{+0}_{-0.035}$ )	110 ( $^{+0}_{-0.035}$ )	110 ( $^{+0}_{-0.035}$ )	110 ( $^{+0}_{-0.035}$ )
LL(without brake)	153.3	147.5	167.5	187.5	152.5	187.5	202
LL(with brake)	192.5	183.5	202	216	181	216	230.7
LS	37	47	47	47	47	47	47
LR	45	55	55	55	55	55	55
LE	5	6	6	6	6	6	6
LG	12	11.5	11.5	11.5	11.5	11.5	11.5
LW	32	36	36	36	36	36	36
RH	18	18	18	18	18	18	18
WK	8	8	8	8	8	8	8
W	8	8	8	8	8	8	8
T	7	7	7	7	7	7	7
TP	M6 Depth 20	M6 Depth 20	M6 Depth 20	M6 Depth 20	M6 Depth 20	M6 Depth 20	M6 Depth 20

Note:

\*1. In servo motor model names, □ signifies encoder type, □ signifies shaft diameter and oil seal

# Ordering Information

## Servo Motor Specifications

### High Inertia ECMC Series -Frame Size 130 mm

ECMC Series	F13		
	08	13	18
Rated output power (kW)	0.85	1.3	1.8
Rated torque (N-m) <sup>1</sup>	5.41	8.34	11.48
Maximum torque (N-m)	13.8	23.3	28.7
Rated speed (r/min)	1500		
Maximum speed (r/min)	3000		
Rated current (Arms)	7.1	12.6	13
Maximum current (Arms)	19.4	38.6	36
Power rating (kW/s)	21.52	34.78	53
Rotor moment of inertia (x10 <sup>-4</sup> kg-m <sup>2</sup> )(Without brake)	13.6	20	24.9
Mechanical time constant (ms)	2.43	1.62	1.7
Torque constant-KT (N-m/A)	0.76	0.66	0.88
Voltage constant-KE (mV/(r/min))	29.2	24.2	32.2
Armature resistance (Ohm)	0.38	0.124	0.185
Armature inductance (mH)	4.77	1.7	2.6
Electrical time constant (ms)	12.6	13.7	14.1
Insulation class	Class A (UL), Class B (CE)		
Insulation resistance	100 MΩ · DC 500V above		
Insulation strength	1.8k Vac, 1 sec		
Weight (kg)(without brake)	8.6	9.4	10.5
Weight (kg)(with brake)	10	10.8	11.9
Max. radial shaft load (N)	490		
Max. thrust shaft load (N)	98		
Power rating (kW/s)(with brake)	19.8	32.7	50.3
Rotor moment of inertia (x10 <sup>-4</sup> kg-m <sup>2</sup> )(with brake)	14.8	21.3	26.2
Mechanical time constant (ms)(with brake)	2.65	1.73	1.79
Brake holding torque [Nt-m (min)] <sup>2</sup>	10		
Brake power consumption (at 20°C)[W]	19		
Brake release time [ms (Max)]	10		
Brake pull-in time [ms (Max)]	70		
Vibration grade (μm)	V15		
Operating temperature (°C)	0°C ~ 40°C (32°F ~ 104°F)		
Storage temperature (°C)	-10°C ~ 80°C (-14°F ~ 176°F)		
Operating humidity	20 ~ 90%RH (non-condensing)		
Storage humidity	20 ~ 90%RH (non-condensing)		
Vibration capacity	2.5 G		
IP Rating	IP65 (when waterproof connectors are used, or when an oil seal is used to be fitted to the rotating shaft)		
Approvals			

Note:

1. □ in the servo model name signifies encoder type.

2. The rated torque is the permissible continuous torque at the operation temperature of 0~40°C when the following heat sink is applied:

ECMC-\_\_10 : 300 mm x 300 mm x 12 mm

ECMC-\_\_13 : 400 mm x 400 mm x 20 mm

ECMC-\_\_18 : 550 mm x 550 mm x 30 mm

Material type: Aluminum- F100, F130, F180

3. The built-in brake of the servo motor is for calmping the shaft. Never use it for decelerating or stopping the motor

# Servo Motor Dimensions

## ECMC Series

### Frame Size 180 mm

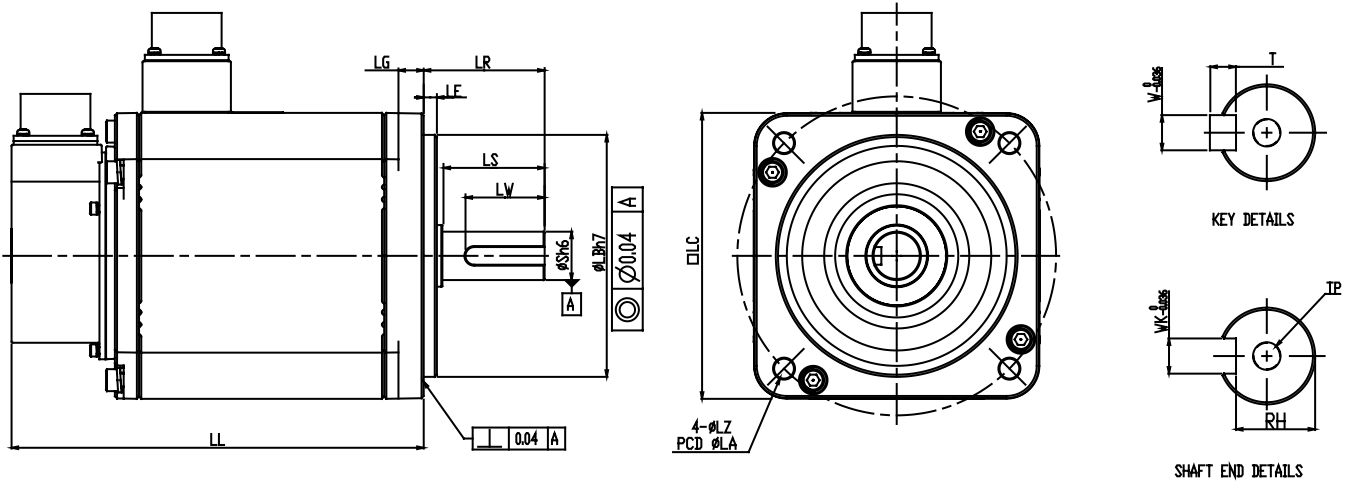

Units: mm

Model	E □ 1820 □ □ *1	E □ 1830 □ □	F □ 1830 □ □
LC	180	180	180
LZ	13.5	13.5	13.5
LA	200	200	200
S	35 <sup>+0</sup> / <sub>-0.016</sub>	35 <sup>+0</sup> / <sub>-0.016</sub>	35 <sup>+0</sup> / <sub>-0.016</sub>
LB	114.3 <sup>+0</sup> / <sub>-0.035</sub>	114.3 <sup>+0</sup> / <sub>-0.035</sub>	114.3 <sup>+0</sup> / <sub>-0.035</sub>
LL(without brake)	169	202.1	202.1
LL(with brake)	203.1	235.3	235.3
LS	73	73	73
LR	79	79	79
LE	4	4	4
LG	20	20	20
LW	63	63	63
RH	30	30	30
WK	10	10	10
W	10	10	10
T	8	8	8
TP	M12 Depth 25	M12 Depth 25	M12 Depth 25

Note:

\*1. In servo motor model names, □ signifies encoder type, □ signifies shaft diameter and oil seal, and □ signifies special code

# Ordering Information

## Speed-Torque Curves (T-N Curves)

### ECMC Torque Features

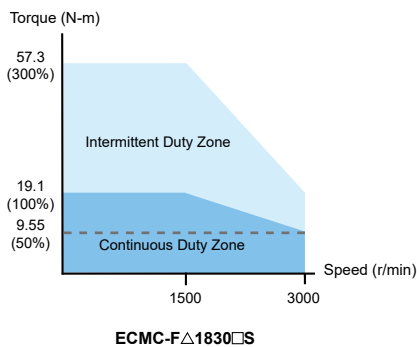
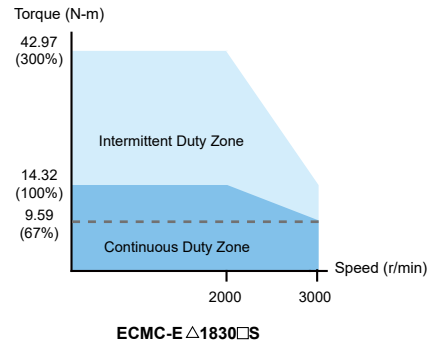
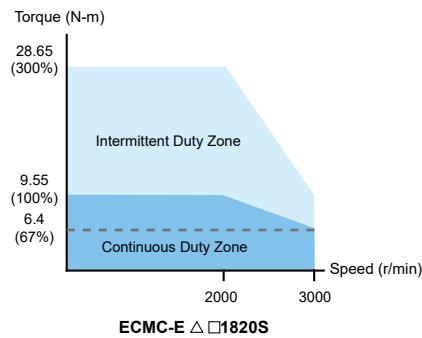
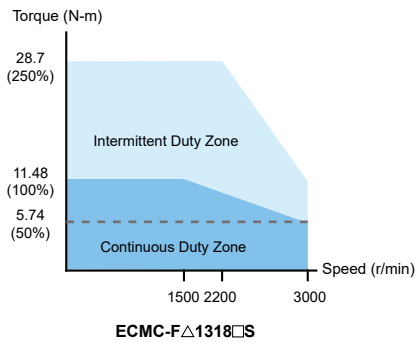
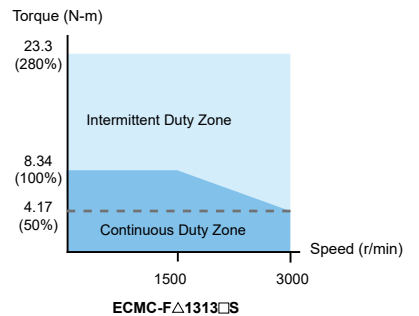
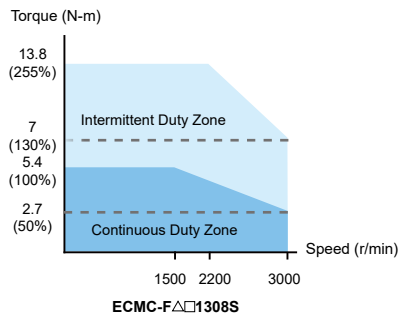
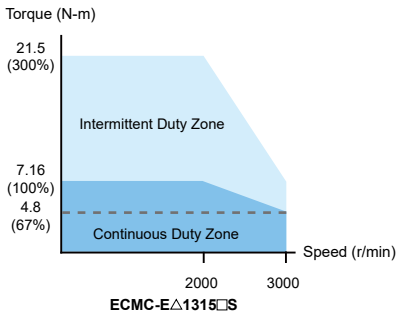
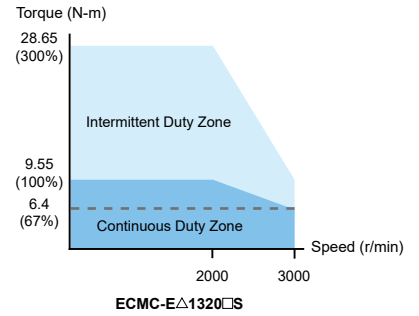
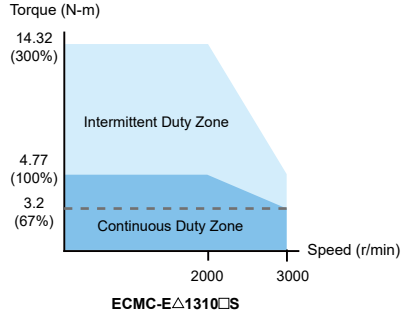
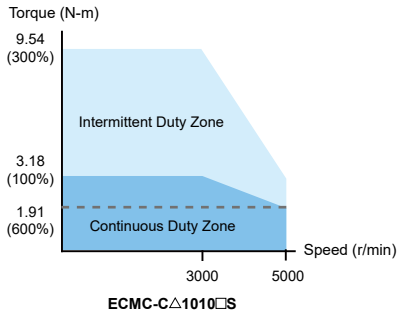



## Servo Drive Accessories Combinations

### 100W Servo Drive and 50W Low / High Inertia Servo Motor

Servo Drive	ASD-A3-0121-□	
Servo Motor Model	ECM-A3L-C △ 040F □ S1 ECM-A3H-C △ 040F □ S1 ECM-A3L-C △ 0401 □ S1 ECM-A3H-C △ 0401 □ S1	
Power Cable (Without Brake)	ACS3-CAPW11XX	
Power Connector (Without Brake)	ASDBCAPW0000	
Power Cable (With Brake)	ACS3-CAPW21XX	
Power Connector (Without Brake)	ASDBCAPW0100	
Flexible Cable	Power Cable (Without Brake)	ASC3-CAPF11XX
	Power Cable (With Brake)	ACS3-CAPF21XX
	Incremental Encoder Cable	ACS3-CAEF10XX
	Absolute Encoder Cable	ACS3-CAEB10XX

(XX signifies cable length, 03 = 3 m, 05 = 5 m, 10=10 m, 20 = 20 m)

### 200W Servo Drive and 200W Low / High Inertia Servo Motor

Servo Drive	ASD-A3-0221-□	
Servo Motor Model	ECM-A3L-C △ 0602 □ S1 ECM-A3H-C △ 0602 □ S1	
Power Cable (Without Brake)	ACS3-CAPW110XX	
Power Connector (Without Brake)	ASDBCAPW0000	
Power Cable (With Brake)	ACS3-CAPW21XX	
Power Connector (Without Brake)	ASDBCAPW0100	
Flexible Cable	Power Cable (Without Brake)	ASC3-CAPF11XX
	Power Cable (With Brake)	ACS3-CAPF21XX
	Incremental Encoder Cable	ACS3-CAEF10XX
	Absolute Encoder Cable	ACS3-CAEB10XX

(XX signifies cable length, 03 = 3 m, 05 = 5 m, 10=10 m, 20 = 20 m)

### 400W Servo Drive and 400W Low / High Inertia Servo Motor

Servo Drive	ASD-A3-0421-□	
Servo Motor Model	ECM-A3L-C △ 0604 □ S1 ECM-A3H-C △ 0604 □ S1 ECM-A3L-C △ 0804 □ S1 ECM-A3H-C △ 0804 □ S1	
Power Cable (Without Brake)	ACS3-CAPW110XX	
Power Connector (Without Brake)	ASDBCAPW0000	
Power Cable (With Brake)	ACS3-CAPW21XX	
Power Connector (Without Brake)	ASDBCAPW0100	
Flexible Cable	Power Cable (Without Brake)	ASC3-CAPF11XX
	Power Cable (With Brake)	ACS3-CAPF21XX
	Incremental Encoder Cable	ACS3-CAEF10XX
	Absolute Encoder Cable	ACS3-CAEB10XX

(XX signifies cable length, 03 = 3 m, 05 = 5 m, 10=10 m, 20 = 20 m)

### 750W Servo Drive and 750W Low / High Inertia Servo Motor

Servo Drive	ASD-A3-0721-□	
Servo Motor Model	ECM-A3L-C △ 0807 □ S1 ECM-A3H-C △ 0807 □ S1	
Power Cable (Without Brake)	ACS3-CAPW110XX	
Power Connector (Without Brake)	ASDBCAPW0000	
Power Cable (With Brake)	ACS3-CAPW21XX	
Power Connector (Without Brake)	ASDBCAPW0100	
Flexible Cable	Power Cable (Without Brake)	ASC3-CAPF11XX
	Power Cable (With Brake)	ACS3-CAPF21XX
	Incremental Encoder Cable	ACS3-CAEF10XX
	Absolute Encoder Cable	ACS3-CAEB10XX

(XX signifies cable length, 03 = 3 m, 05 = 5 m, 10=10 m, 20 = 20 m)

### 1 kW Servo Drive and 1kW Medium Inertia Servo Motor and 850W High Inertia Servo Motor

Servo Drive	ASD-A3-1021-□	
Servo Motor Model	ECMC-CW1010 □ S ECMC-EW1310 □ S ECMC-FW1308 □ S	
Power Cable (Without Brake)	ACS3-CAPW12XX <sup>4</sup>	
Power Cable (With Brake)	ACS3-CAPW22XX <sup>4</sup>	
Power Connector	ASD-CAPW1000	
Flexible Cable	Power Cable (Without Brake)	-
	Power Cable (With Brake)	-
	Incremental Encoder Cable	ACS3-CAEF30XX
	Absolute Encoder Cable	ACS3-CAEB30XX

(XX signifies cable length, 03 = 3 m, 05 = 5 m, 10=10 m, 20 = 20 m)

### 1.5kW Servo Drive and 1.5kW Medium Inertia Servo Motor

Servo Drive	ASD-A3-1521-□	
Servo Motor Model	ECMC-EW1315 □ S	
Power Cable (Without Brake)	ACS3-CAPW12XX <sup>4</sup>	
Power Cable (With Brake)	ACS3-CAPW22XX <sup>4</sup>	
Power Connector	ASD-CAPW1000	
Flexible Cable	Power Cable (Without Brake)	-
	Power Cable (With Brake)	-
	Incremental Encoder Cable	ACS3-CAEF30XX
	Absolute Encoder Cable	ACS3-CAEB30XX

(XX signifies cable length, 03 = 3 m, 05 = 5 m, 10=10 m, 20 = 20 m)

# Ordering Information

## Servo Drive Accessories Combinations

### 2kW Servo Drive and 2kW Medium Inertia Servo Motor and 1.3kW, 1.8kW High Inertia Servo Motor

Servo Drive	ASD-A3-2023 □	
Servo Motor Model	ECMC-EW1320 □ S ECMC-FW1313 □ S ECMC-FW1318 □ S	
Power Cable (Without Brake)	ACS3-CAPW13XX <sup>4</sup>	
Power Cable (With Brake)	ACS3-CAPW23XX <sup>4</sup>	
Power Connector	ASD-CAPW1000	
Flexible Cable	Power Cable (Without Brake)	-
	Power Cable (With Brake)	-
	Incremental Encoder Cable	ACS3-CAEF30XX
	Absolute Encoder Cable	ACS3-CAEB30XX

(XX signifies cable length, 03 = 3 m, 05 = 5 m, 10=10 m, 20 = 20 m)

### 2kW Servo Drive and 2kW Medium Inertia Servo Motor

Servo Drive	ASD-A3-2023- □	
Servo Motor Model	ECMC-EW1820 □ S	
Power Cable (Without Brake)	ACS3-CAPW14XX <sup>4</sup>	
Power Cable (With Brake)	ACS3-CAPW24XX <sup>4</sup>	
Power Connector	ASD-CAPW2000	
Flexible Cable	Power Cable (Without Brake)	-
	Power Cable (With Brake)	-
	Incremental Encoder Cable	ACS3-CAEF30XX
	Absolute Encoder Cable	ACS3-CAEB30XX

(XX signifies cable length, 03 = 3 m, 05 = 5 m, 10=10 m, 20 = 20 m)

### 3kW Servo Drive and 3kW Medium Inertia Servo Motor

Servo Drive	ASD-A3-3023- □	
Servo Motor Model	ECMC-EW1830 □ S ECMC-FW1830 □ S	
Power Cable (Without Brake)	ACS3-CAPW14XX <sup>4</sup>	
Power Cable (With Brake)	ACS3-CAPW24XX <sup>4</sup>	
Power Connector	ASD-CAPW2000	
Flexible Cable	Power Cable (Without Brake)	-
	Power Cable (With Brake)	-
	Incremental Encoder Cable	ACS3-CAEF30XX
	Absolute Encoder Cable	ACS3-CAEB30XX

(XX signifies cable length, 03 = 3 m, 05 = 5 m, 10=10 m, 20 = 20 m)

#### Note:

- in servo drive model name signifies the ASD-A3 models. Please refer to the model name information in the ordered products.
- Δ in servo drive model name signifies the encoder type. Please refer to User Manual Chapter 1 for more information.
- in servo drive model name signifies brake or shaft/oil seal type
- Only 3m and 5m power cables are available



## Optional Cables and Connectors

### • Power Connectors

ASDBCAPW0000 (for 200V drives)

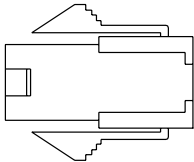

ASD-CAPW1000

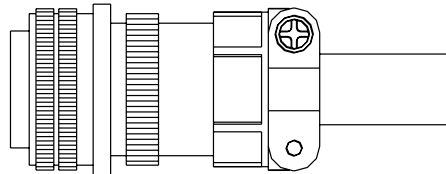

ASDBCAPW0100 (for 200V drives, with brake cable)

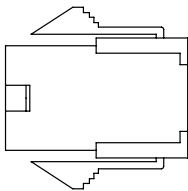

ASD-CAPW2000

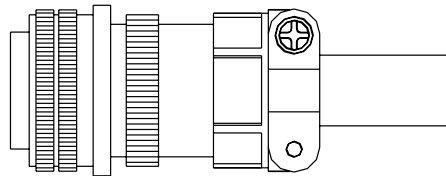

### • Power Cables

ACS3-CAPW1103 · ACS3-CAPW1105 · ACS3-CAPW1110 · ACS3-CAPW1120 · ACS3-CAPF1103 · ACS3-CAPF1105 · ACS3-CAPF1110 · ACS3-CAPF1120 (for 200V drives)

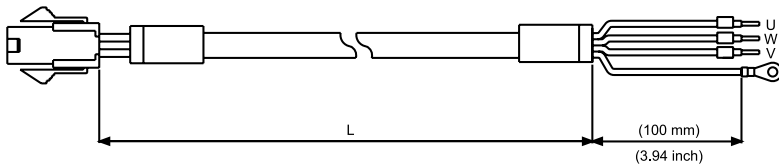

Cable	Part No.	L	
		mm	inch
Standard	ACS3-CAPW1103	3000 ± 50	118 ± 2
	ACS3-CAPW1105	5000 ± 50	197 ± 2
	ACS3-CAPW1110	10000 ± 100	398 ± 4
	ACS3-CAPW1120	20000 ± 100	788 ± 4
Flexible	ACS3-CAPF1103	3000 ± 50	118 ± 2
	ACS3-CAPF1105	5000 ± 50	197 ± 2
	ACS3-CAPF1110	10000 ± 100	394 ± 4
	ACS3-CAPF1120	20000 ± 100	788 ± 4

ACS3-CAPW2103 · ACS3-CAPW2105 · ACS3-CAPW2110 · ACS3-CAPW2120 · ACS3-CAPF2103 · ACS3-CAPF2105 · ACS3-CAPF2110 · ACS3-CAPF2120 (for 200V drives, with brake cable)

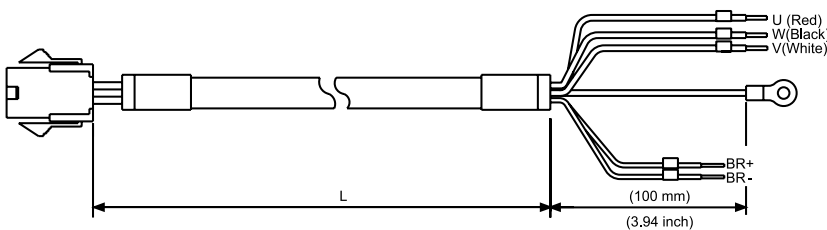

Cable	Part No.	L	
		mm	inch
Standard	ACS3-CAPW2103	3000 ± 50	118 ± 2
	ACS3-CAPW2105	5000 ± 50	197 ± 2
	ACS3-CAPW2110	10000 ± 100	394 ± 4
	ACS3-CAPW2120	20000 ± 100	788 ± 4
Flexible	ACS3-CAPF2103	3000 ± 50	118 ± 2
	ACS3-CAPF2105	5000 ± 50	197 ± 2
	ACS3-CAPF2110	10000 ± 100	394 ± 4
	ACS3-CAPF2120	20000 ± 100	788 ± 4

# Ordering Information

## Optional Cables and Connectors

### • Power Cables

#### ACS3-CAPW1203, ACS3-CAPW1205

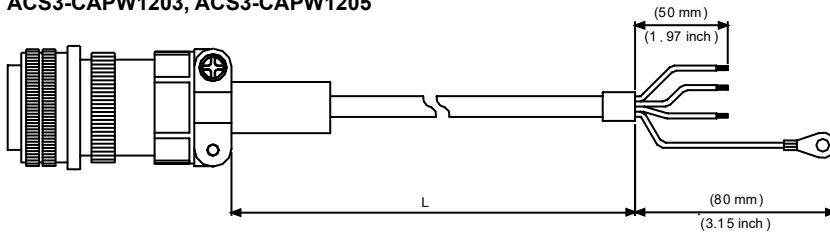

Cable	Part No.	Straight	L	
			mm	inch
Standard	ACS3-CAPW1203	3106A-20-18S	3000 ± 100	118 ± 4
	ACS3-CAPW1205	3106A-20-18S	5000 ± 100	197 ± 4

#### ACS3-CAPW2203, ACS3-CAPW2205 (with brake cable)

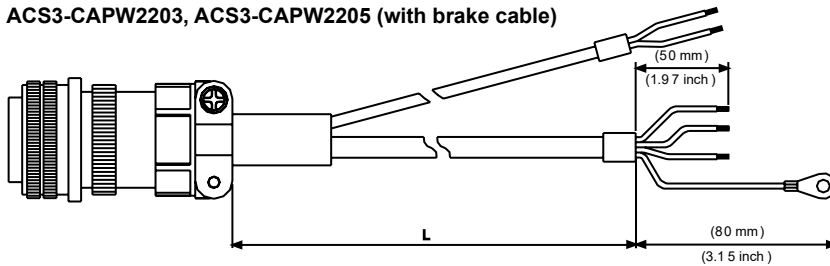

Cable	Part No.	Straight	L	
			mm	inch
Standard	ACS3-CAPW2203	3106A-20-18S	3000 ± 100	118 ± 4
	ACS3-CAPW2205	3106A-20-18S	5000 ± 100	197 ± 4

#### ACS3-CAPW1303, ACS3-CAPW1305

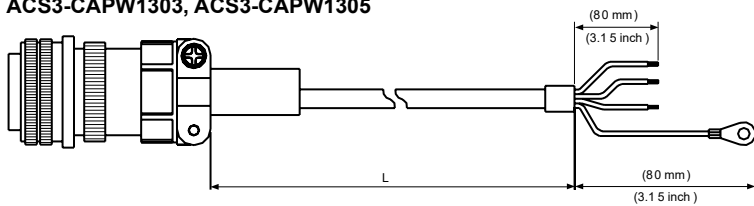

Cable	Part No.	Straight	L	
			mm	inch
Standard	ACS3-CAPW1303	3106A-20-18S	3000 ± 100	118 ± 4
	ACS3-CAPW1305	3106A-20-18S	5000 ± 100	197 ± 4

#### ACS3-CAPW2303, ACS3-CAPW2305 (with brake cable)

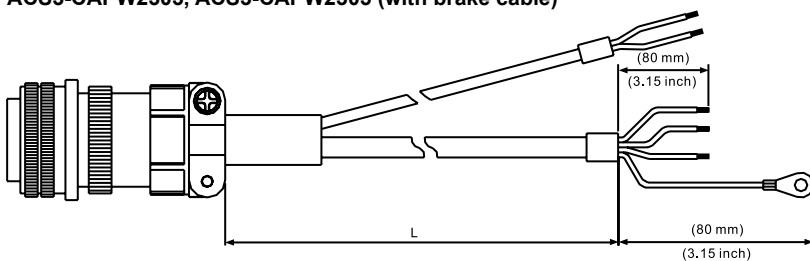

Cable	Part No.	Straight	L	
			mm	inch
Standard	ACS3-CAPW2303	3106A-20-18S	3000 ± 100	118 ± 4
	ACS3-CAPW2305	3106A-20-18S	5000 ± 100	197 ± 4

• Power Cables

ACS3-CAPW1403, ACS3-CAPW1405

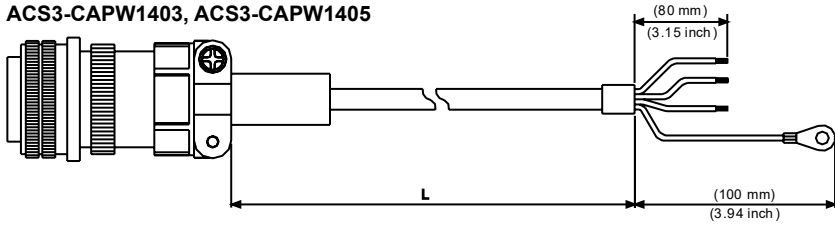

Cable	Part No.	Straight	L	
			mm	inch
Standard	ACS3-CAPW1403	3106A-24-11S	3000 ± 100	118 ± 4
	ACS3-CAPW1405	3106A-24-11S	5000 ± 100	197 ± 4

ACS3-CAPW2403, ACS3-CAPW2405 (with brake cable)

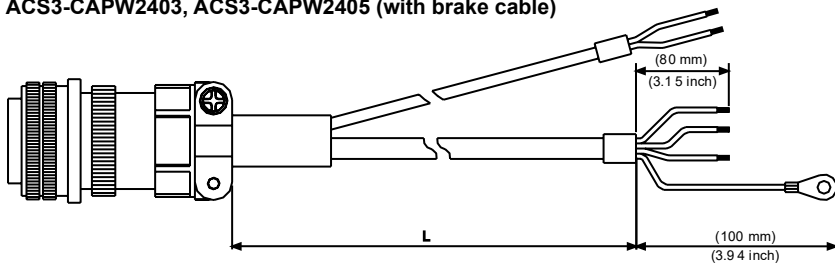

Cable	Part No.	Straight	L	
			mm	inch
Standard	ACS3-CAPW2403	3106A-24-11S	3000 ± 100	118 ± 4
	ACS3-CAPW2405	3106A-24-11S	5000 ± 100	197 ± 4

• Encoder Connectors

ACS3-CNEN1100

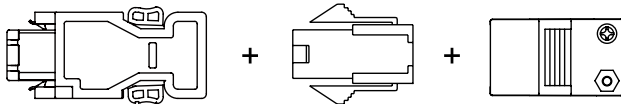

ACS3-CNENC200

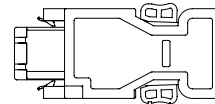

ACS3-CNEN3100

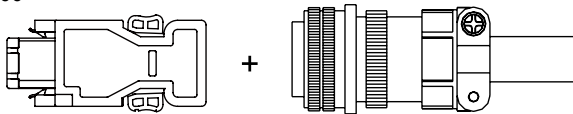

• Incremental Encoder Cables

ACS3-CAEF1003 · ACS3-CAEF1005 · ACS3-CAEF1010 · ACS3-CAEF1020

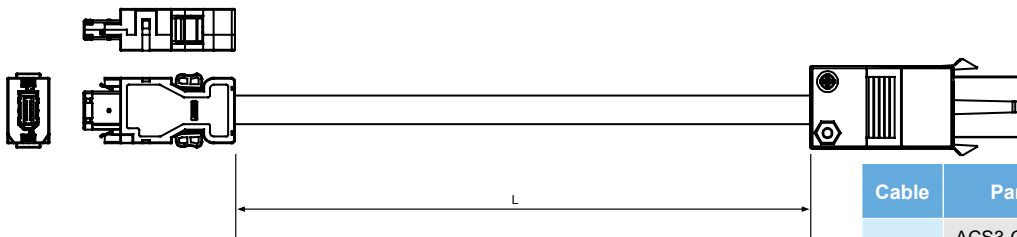

Cable	Part No.	L	
		mm	inch
Flexible	ACS3-CAEF1003	3000 ± 50	118 ± 2
	ACS3-CAEF1005	5000 ± 50	197 ± 2
	ACS3-CAEF1010	10000 ± 100	394 ± 4
	ACS3-CAEF1020	20000 ± 100	788 ± 4



# Ordering Information

## Optional Cables and Connectors

### • Incremental Encoder Cables

ACS3-CAEF3003 · ACS3-CAEF3005 · ACS3-CAEF3010 · ACS3-CAEF3020

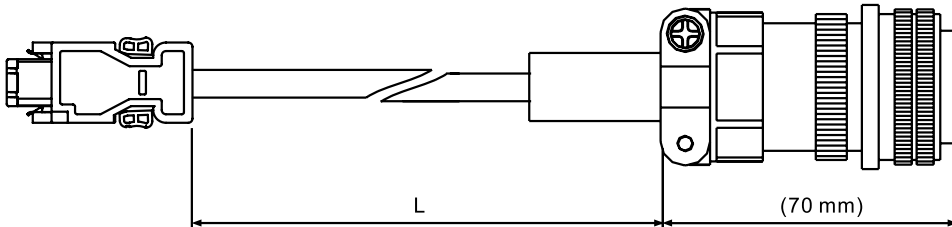

Cable	Part No.	Straight	L	
			mm	inch
Flexible	ACS3-CAEF3003	3106A-20-29S	3000 ± 50	118 ± 2
	ACS3-CAEF3005	3106A-20-29S	5000 ± 50	197 ± 2
	ACS3-CAEF3010	3106A-20-29S	10000 ± 100	394 ± 4
	ACS3-CAEF3020	3106A-20-29S	20000 ± 100	788 ± 4

### • Absolute Encoder Cables

ACS3-CAEB1003 · ACS3-CAEB1005 · ACS3-CAEB1010 · ACS3-CAEB1020

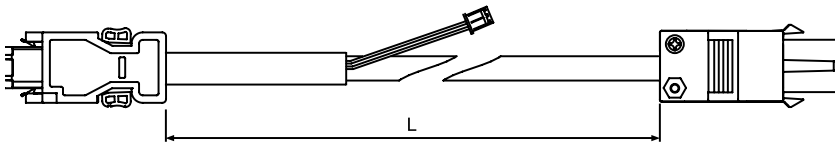

Cable	Part No.	L	
		mm	inch
Flexible	ACS3-CAEB1003	3000 ± 50	118 ± 2
	ACS3-CAEB1005	5000 ± 50	197 ± 2
	ACS3-CAEB1010	10000 ± 100	394 ± 4
	ACS3-CAEB1020	20000 ± 100	788 ± 4

ACS3-CAEB3003 · ACS3-CAEB3005 · ACS3-CAEB3010 · ACS3-CAEB3020

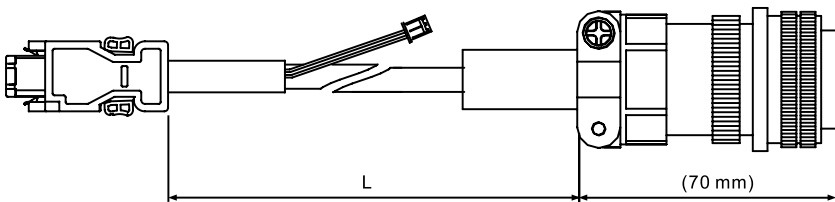

Cable	Part No.	L	
		mm	inch
Flexible	ACS3-CAEB3003	3000 ± 50	118 ± 2
	ACS3-CAEB3005	5000 ± 50	197 ± 2
	ACS3-CAEB3010	10000 ± 100	394 ± 4
	ACS3-CAEB3020	20000 ± 100	788 ± 4

### • Battery Boxes with batteries Units: mm

Single Battery Box  
ASD-MDBT0100

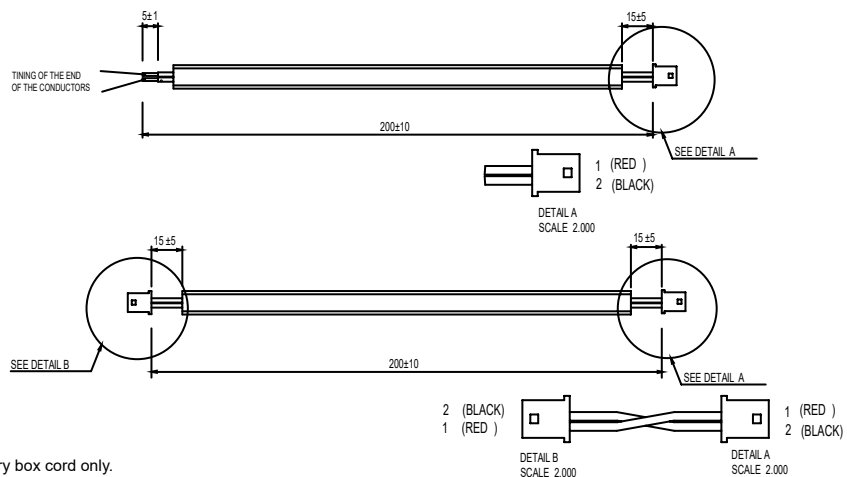
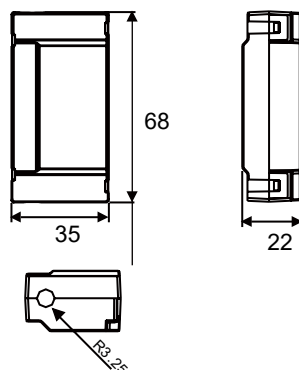

Please contact Delta Global Service team if ordering battery box cord only.

• **Battery Boxes with batteries** Units: mm

**Dual Battery Box ASD-MDBT0200**

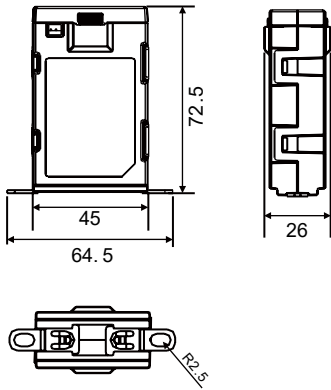

Please contact Delta Global Service team if ordering battery box cord only.

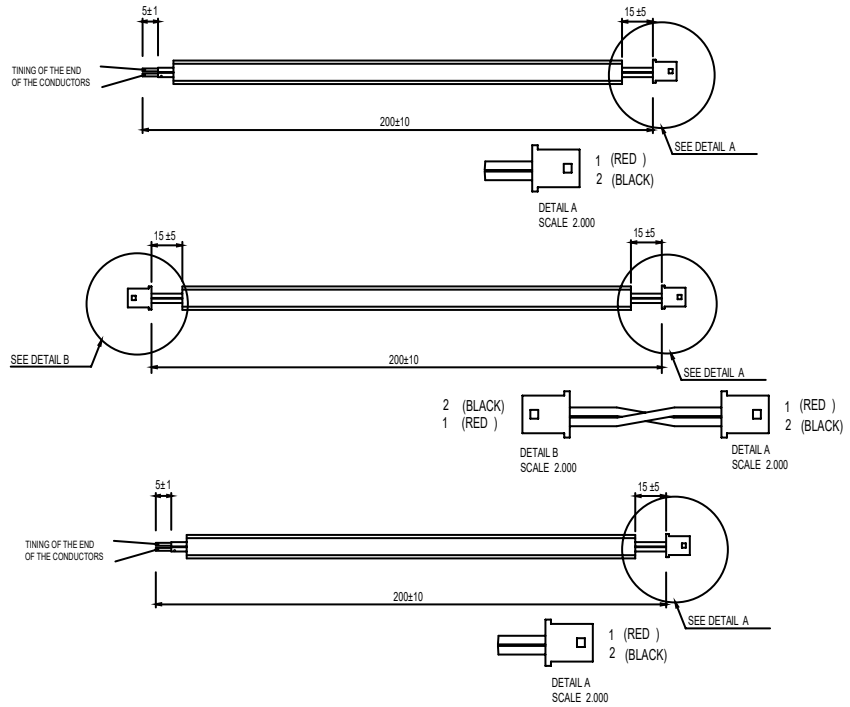

• **Terminal Block Module**

**ACS3-MDTB5000**

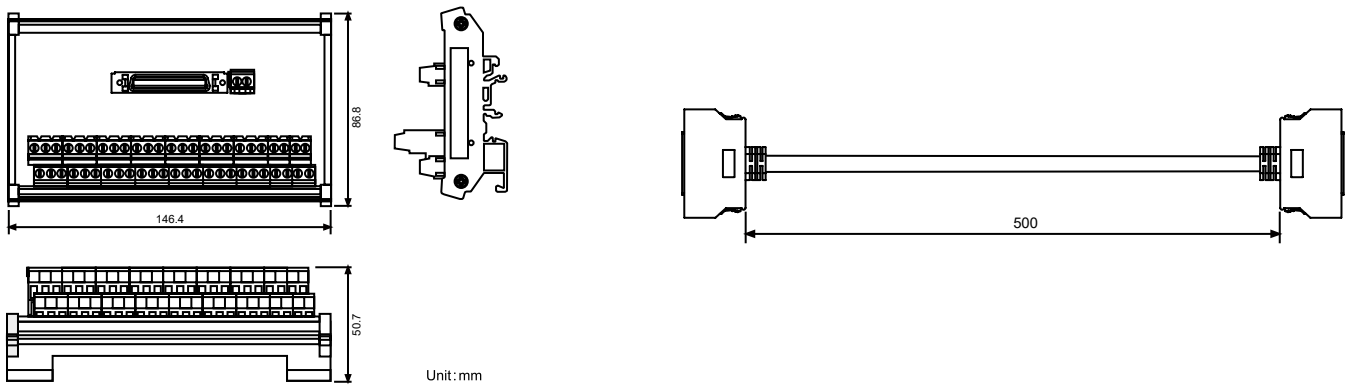

• **CANopen Communication Cable**

**UC-CMC030-01A, UC-CMC050-01A** L ± 10

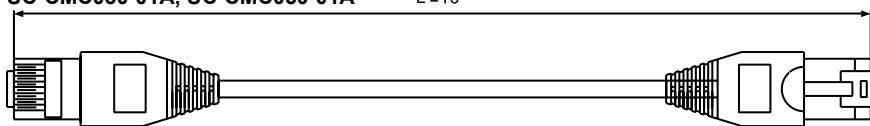

Item	Part No.	L	
		mm	inch
1	UC-CMC030-01A	3000 ± 10	11 ± 0.4
2	UC-CMC050-01A	5000 ± 10	19 ± 0.4

# Ordering Information

## Optional Cables and Connectors

- I/O Signal Connector (CN1)

ACS3-CNADC150

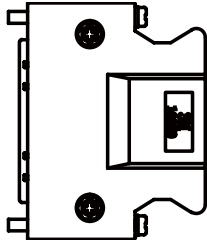

- Ferrite Rings

ASD-ACFC7K00

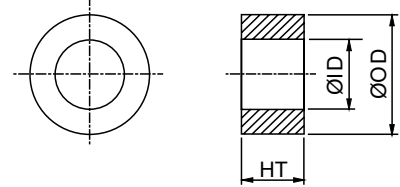

- CANopen Distribution Box Units: mm [inch]

TAP-CN03

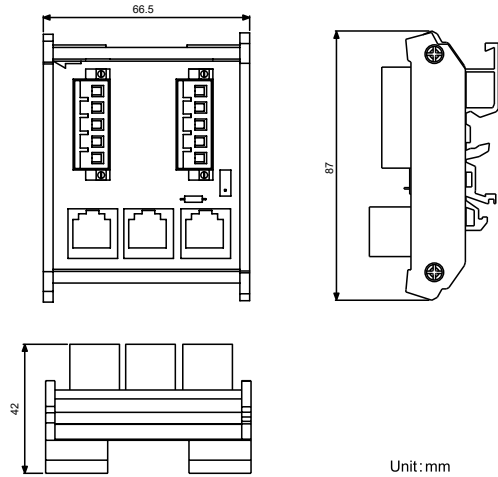

- A3 CN3 RS-485 Tap

ACS3-CNADC3RC

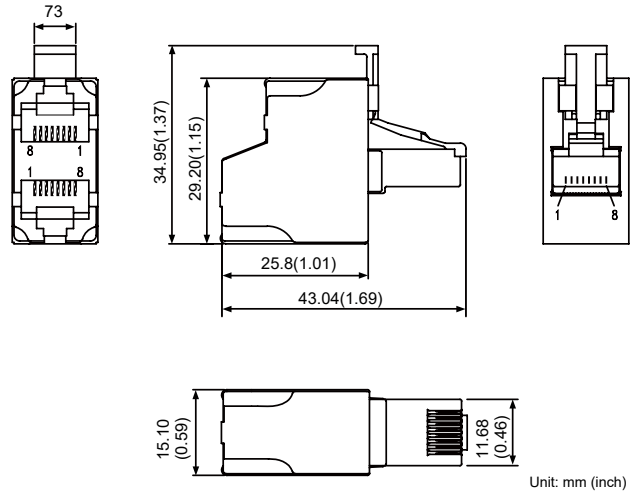

- A3 / A2 Adapter Cable

A3/A2 CN1 Adapter Cable  
ACS3-CAADC1

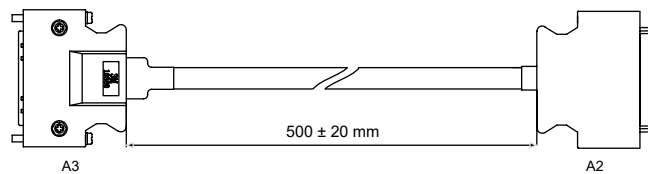

A3/A2 CN2 Adapter Cable  
ACS3-CAADC2

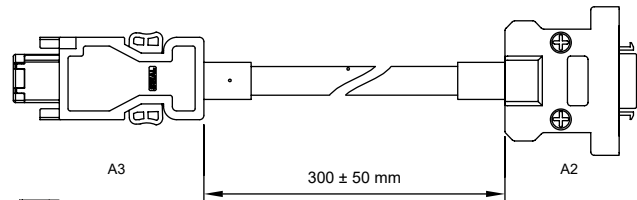

A3/A2 CN5 Adapter Cable  
ACS3-CAADC5

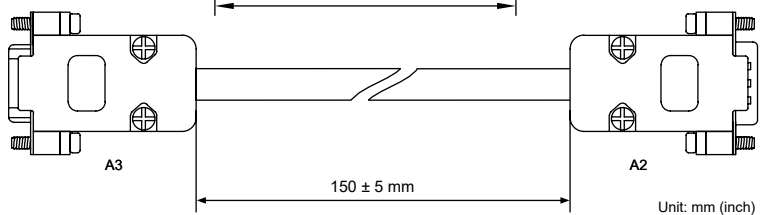

• **A3 CN3 RS-485 / CANOpen Termination Resistor**

ACS3-CNADC3TR

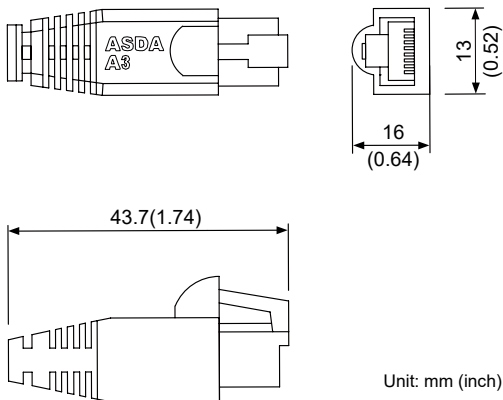

• **A3 CN6 DMCNET Termination Resistor**

ASD-TR-DM0008

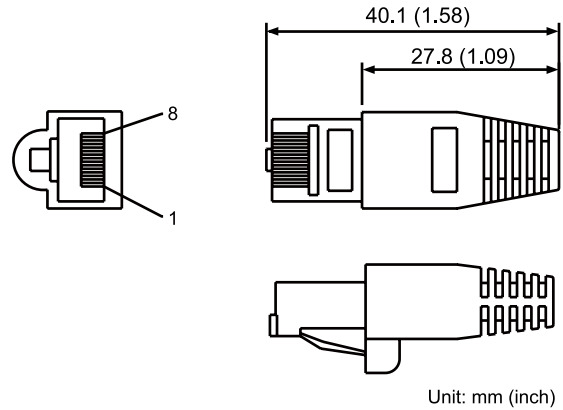

• **CN4 Mini USB Module**

UC-PRG015-01B, UC-PRG030-01B

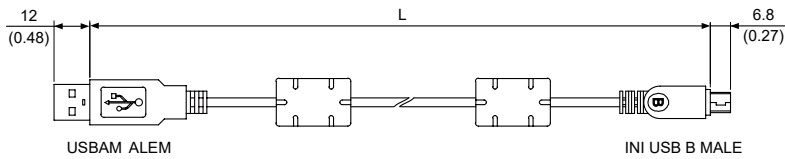
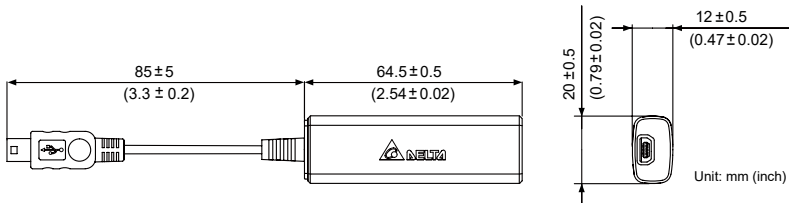

Item	Part No.	L	
		mm	inch
1	UC-PRG015-01B	1500 ± 100	59 ± 4
2	UC-PRG030-01B	3000 ± 100	118 ± 4

UC-ADP01-A

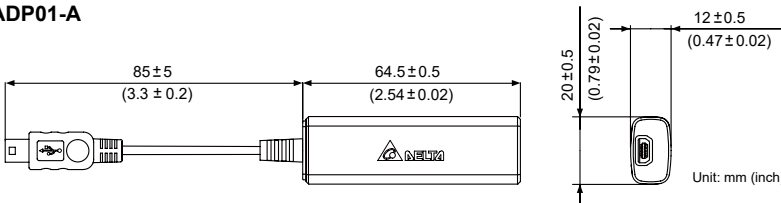

UC-PRG015-01A/ UC-PRG030-01A

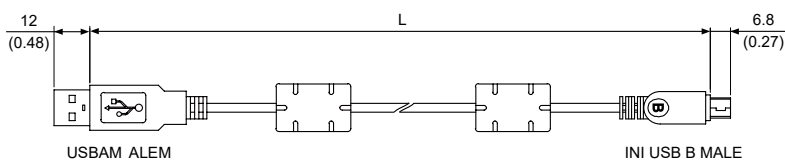

Item	Part No.	L	
		mm	inch
1	UC-PRG015-01A	1500 ± 100	59 ± 4
2	UC-PRG030-01A	3000 ± 100	118 ± 4





## Position (PR) Control Mode (for Internal Procedure Control)

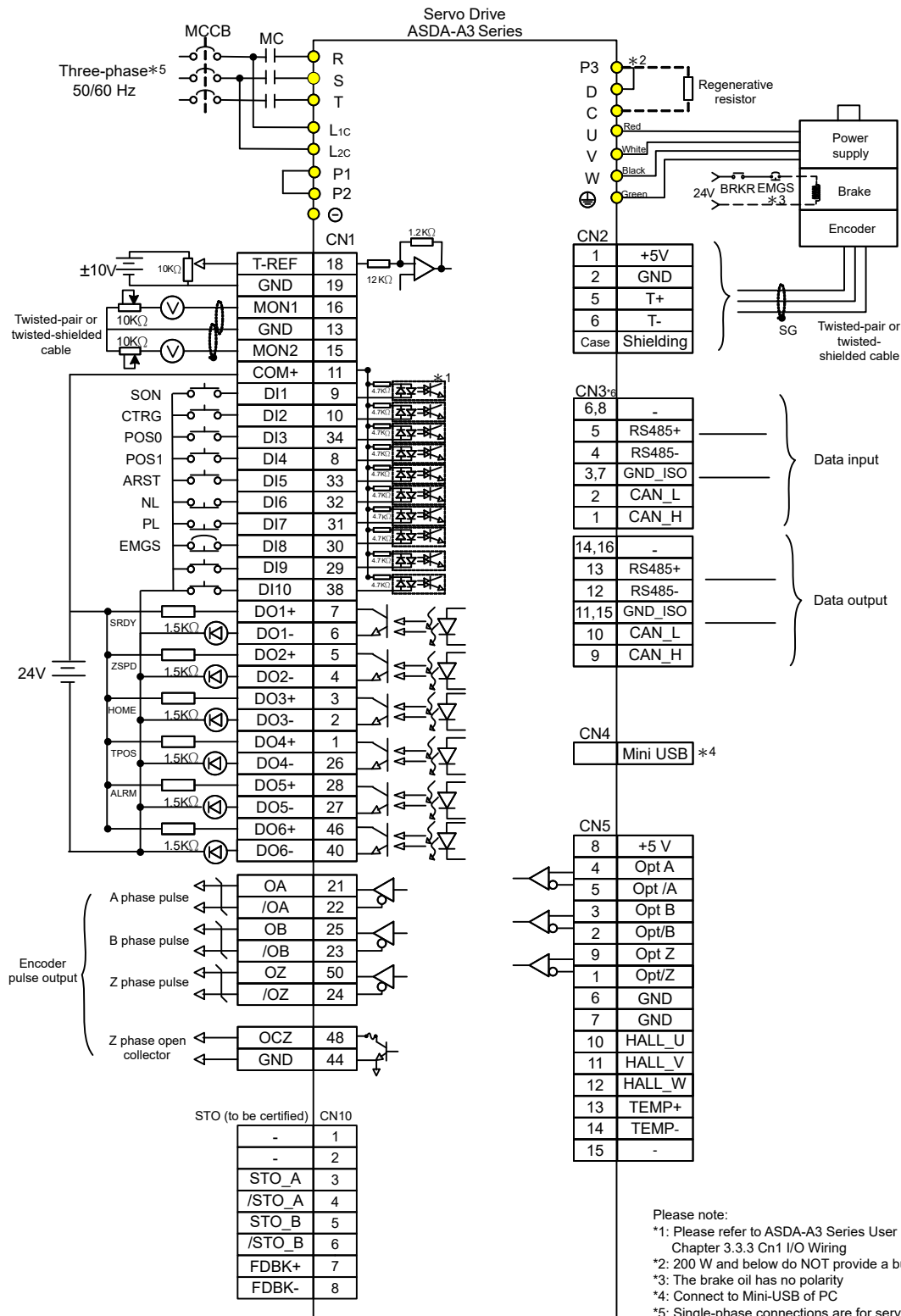

Please note:  
 \*1: Please refer to ASDA-A3 Series User Manual, Chapter 3.3.3 Cn1 I/O Wiring  
 \*2: 200 W and below do NOT provide a built-in regenerative resistor  
 \*3: The brake oil has no polarity  
 \*4: Connect to Mini-USB of PC  
 \*5: Single-phase connections are for servo drives 1.5kW and below only  
 \*6: Only A3-L is without dual ports

# Wiring

## Torque (T) Mode Standard Wiring

(for Analog Voltage Input and Internal Parameter Setting)

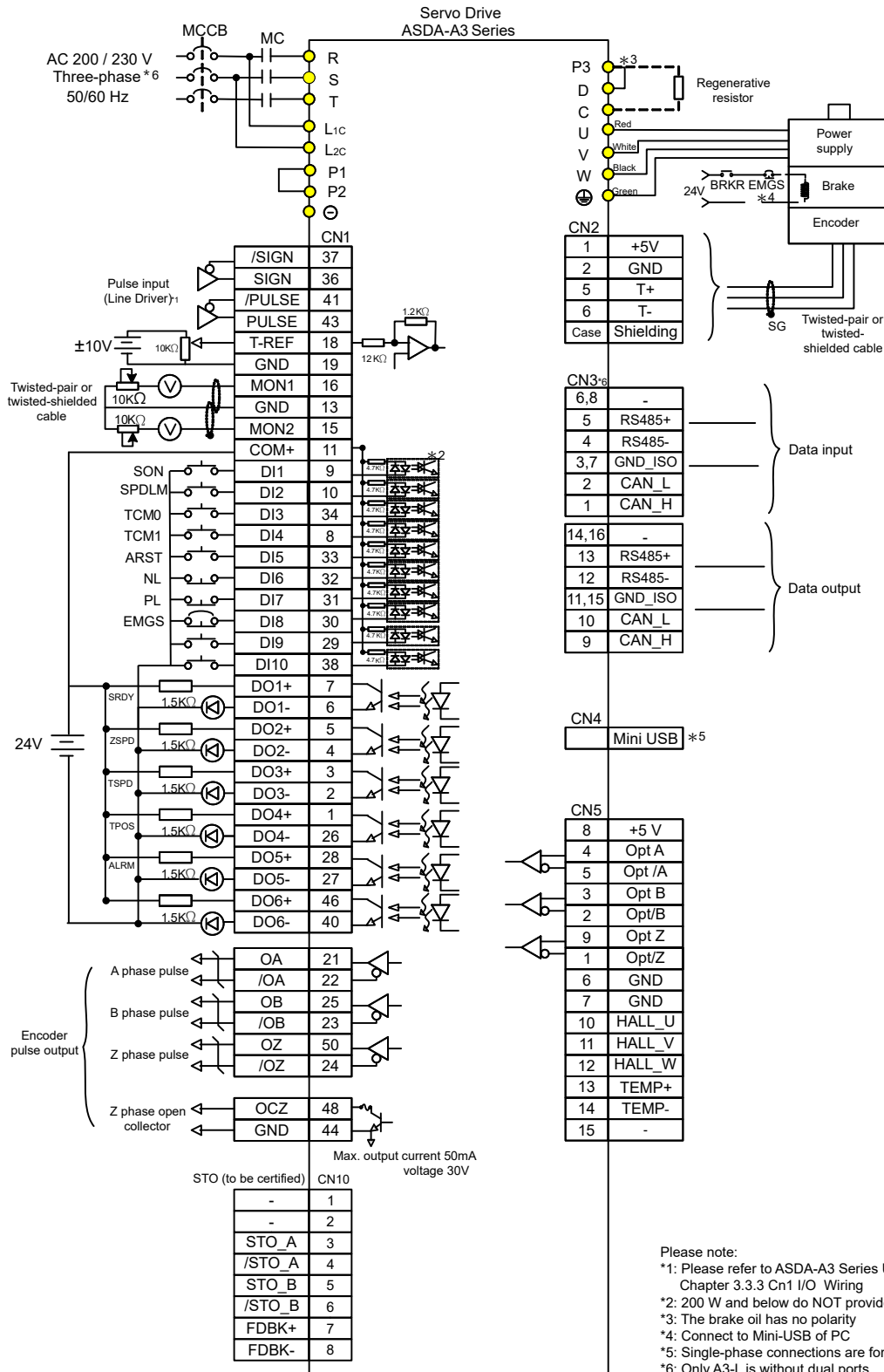

# Speed (S) Mode (for Analog Voltage Input and Internal Parameter Setting)

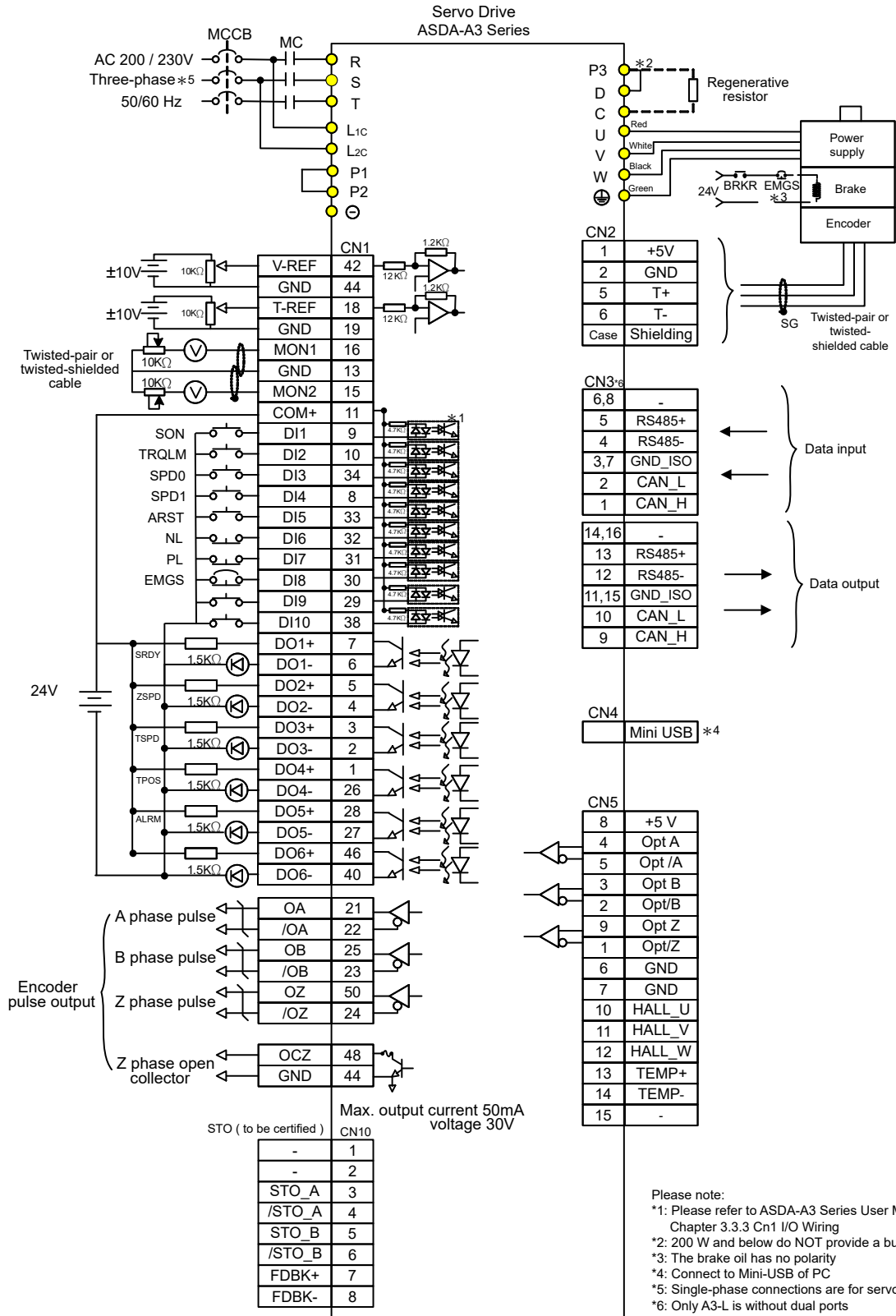

# Wiring

## Communication mode (CANopen)

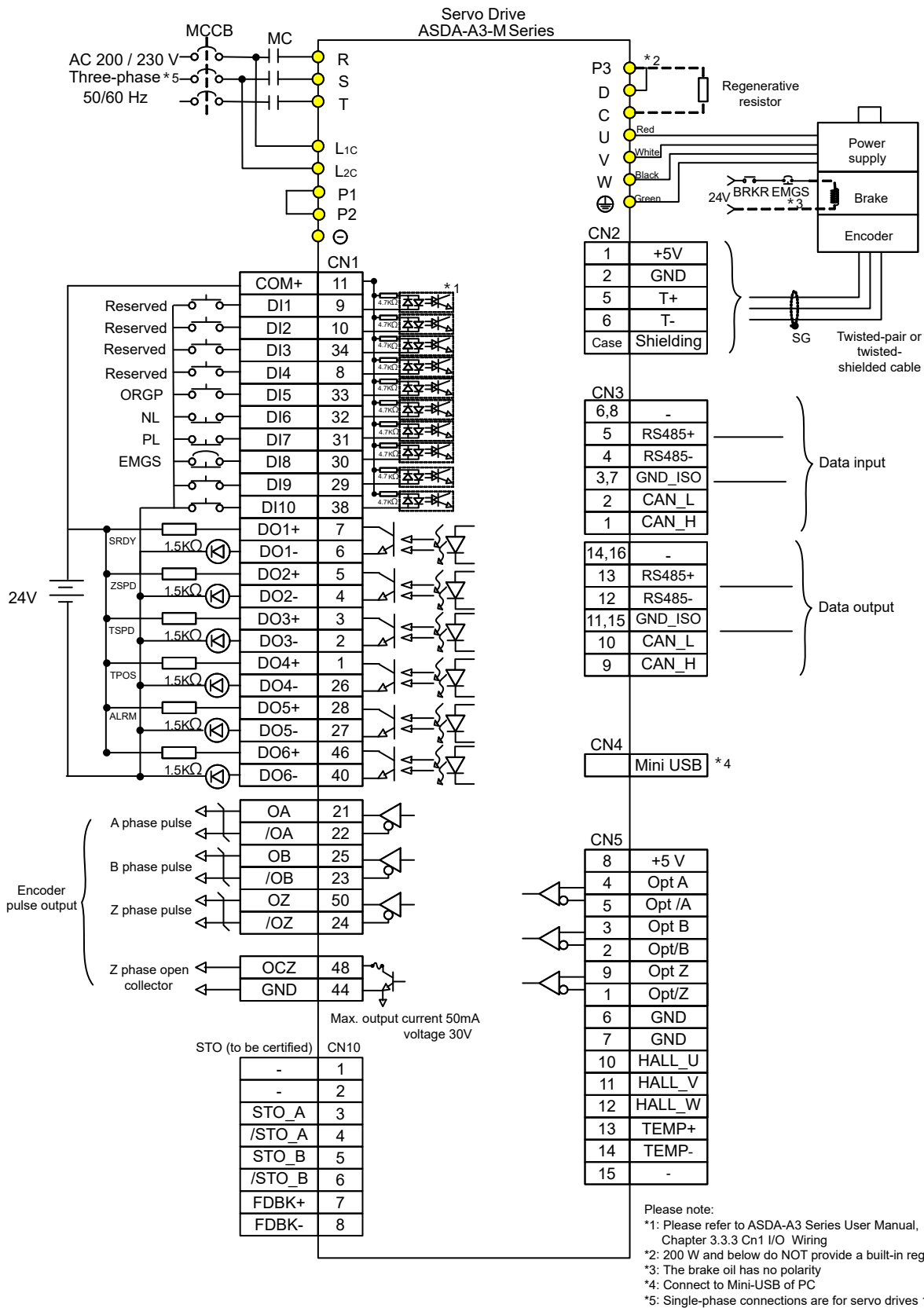

# Communication mode (EtherCAT)

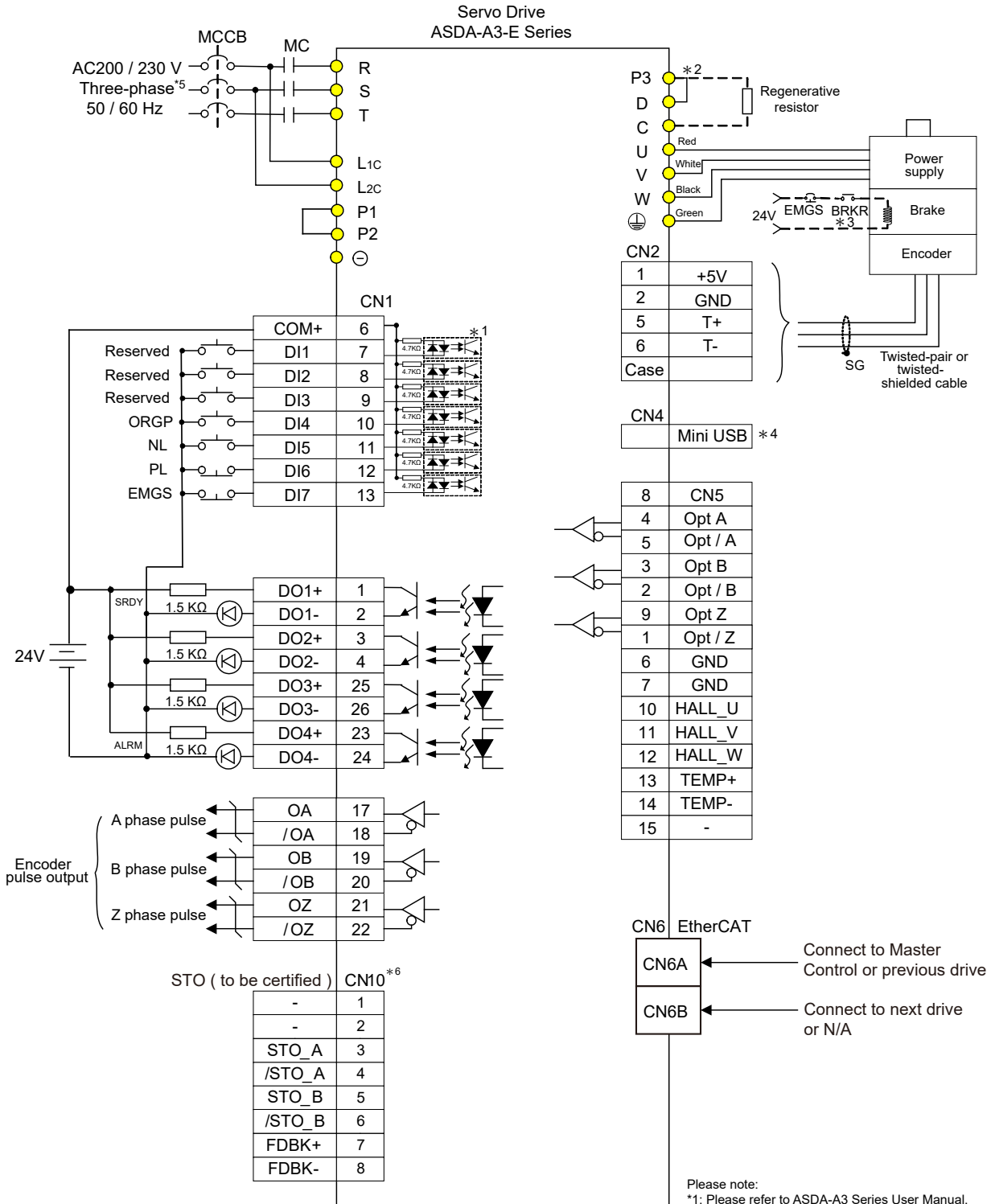

Please note:

- \*1: Please refer to ASDA-A3 Series User Manual, Chapter 3.3.3 Cn1 I/O Wiring
- \*2: 200 W and below do NOT provide a built-in regenerative resistor
- \*3: The brake oil has no polarity
- \*4: Connect to Mini-USB of PC
- \*5: Single-phase connections are for servo drives 1.5kW and below only
- \*6: Please refer to ASDA-A3 manual Chapter 3.9CN10 Wiring Definition



# Wiring

## Communication mode (DMCNET)

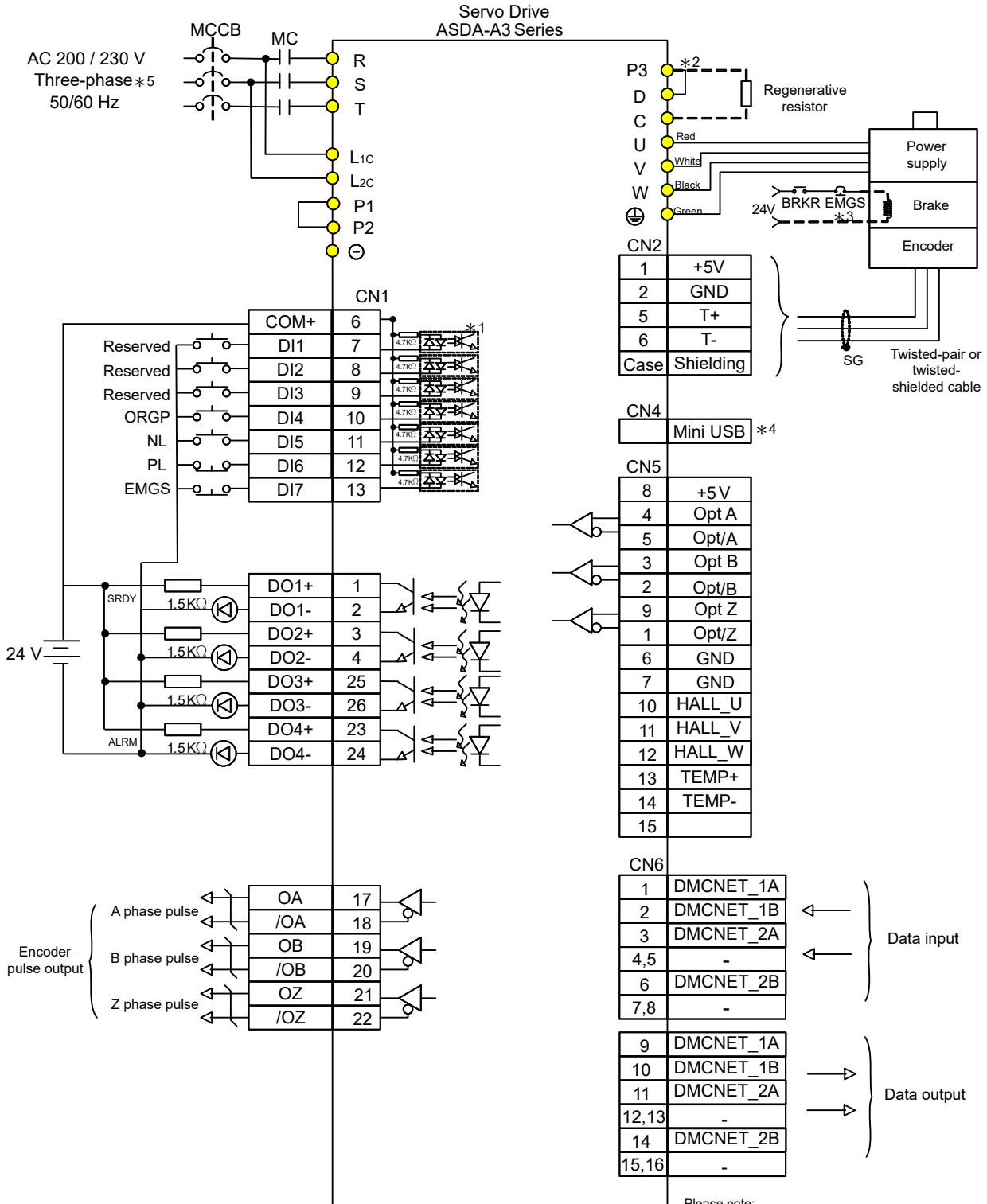

Please note:

- \*1: Please refer to ASDA-A3 Series User Manual, Chapter 3.3.3 Cn1 I/O Wiring
- \*2: 200 W and below do NOT provide a built-in regenerative resistor
- \*3: The brake oil has no polarity
- \*4: Connect to Mini-USB of PC
- \*5: Single-phase connections are for servo drives 1.5kW and below only





Smarter. Greener. Together.

## Industrial Automation Headquarters

### Delta Electronics, Inc.

Taoyuan Technology Center  
No.18, Xinglong Rd., Taoyuan District,  
Taoyuan City 33068, Taiwan  
TEL: 886-3-362-6301 / FAX: 886-3-371-6301

## Asia

### Delta Electronics (Shanghai) Co., Ltd.

No.182 Minyu Rd., Pudong Shanghai, P.R.C.  
Post code : 201209  
TEL: 86-21-6872-3988 / FAX: 86-21-6872-3996  
Customer Service: 400-820-9595

### Delta Electronics (Japan), Inc.

Tokyo Office  
Industrial Automation Sales Department  
2-1-14 Shibadaimon, Minato-ku  
Tokyo, Japan 105-0012  
TEL: 81-3-5733-1155 / FAX: 81-3-5733-1255

### Delta Electronics (Korea), Inc.

Seoul Office  
1511, 219, Gasan Digital 1-Ro., Geumcheon-gu,  
Seoul, 08501 South Korea  
TEL: 82-2-515-5305 / FAX: 82-2-515-5302

### Delta Energy Systems (Singapore) Pte Ltd.

4 Kaki Bukit Avenue 1, #05-04, Singapore 417939  
TEL: 65-6747-5155 / FAX: 65-6744-9228

### Delta Electronics (India) Pvt. Ltd.

Plot No.43, Sector 35, HSIIDC Gurgaon,  
PIN 122001, Haryana, India  
TEL: 91-124-4874900 / FAX : 91-124-4874945

### Delta Electronics (Thailand) PCL.

909 Soi 9, Moo 4, Bangpoo Industrial Estate (E.P.Z),  
Pattana 1 Rd., T.Phraksa, A.Muang,  
Samutprakarn 10280, Thailand  
TEL: 66-2709-2800 / FAX : 662-709-2827

### Delta Electronics (Australia) Pty Ltd.

Unit 20-21/45 Normanby Rd., Notting Hill Vic 3168, Australia  
TEL: 61-3-9543-3720

## Americas

### Delta Electronics (Americas) Ltd.

Raleigh Office  
P.O. Box 12173, 5101 Davis Drive,  
Research Triangle Park, NC 27709, U.S.A.  
TEL: 1-919-767-3813 / FAX: 1-919-767-3969

### Delta Electronics Brazil

São Paulo Sales Office  
Rua Itapeva, 26 - 3º, andar Edifício Itapeva,  
One - Bela Vista 01332-000 - São Paulo - SP - Brazil  
TEL: 55-12-3932-2300 / FAX: 55-12-3932-237

### Delta Electronics International Mexico S.A. de C.V.

Mexico Office  
Gustavo Baz No. 309 Edificio E PB 103  
Colonia La Loma, CP 54060  
Tlalnepantla, Estado de México  
TEL: 52-55-3603-9200

## EMEA

### Headquarters: Delta Electronics (Netherlands) B.V.

Sales: Sales.IA.EMEA@deltaww.com  
Marketing: Marketing.IA.EMEA@deltaww.com  
Technical Support: iatechnicalsupport@deltaww.com  
Customer Support: Customer-Support@deltaww.com  
Service: Service.IA.emea@deltaww.com  
TEL: 31(0)40 800 3900

### BENELUX: Delta Electronics (Netherlands) B.V.

De Witbogt 20, 5652 AG Eindhoven, The Netherlands  
Mail: Sales.IA.Benelux@deltaww.com  
TEL: 31(0)40 800 3900

### DACH: Delta Electronics (Netherlands) B.V.

Coesterweg 45, D-59494 Soest, Germany  
Mail: Sales.IA.DACH@deltaww.com  
TEL: 49(0)2921 987 0

### France: Delta Electronics (France) S.A.

ZI du bois Challand 2, 15 rue des Pyrénées,  
Lisses, 91090 Evry Cedex, France  
Mail: Sales.IA.FR@deltaww.com  
TEL: 33(0)1 69 77 82 60

### Iberia: Delta Electronics Solutions (Spain) S.L.U

Ctra. De Villaverde a Vallecas, 265 1º Dcha Ed.  
Hormigueras – P.I. de Vallecas 28031 Madrid  
TEL: 34(0)91 223 74 20

Carrer Llacuna 166, 08018 Barcelona, Spain

Mail: Sales.IA.Iberia@deltaww.com

### Italy: Delta Electronics (Italy) S.r.l.

Via Meda 2-22060 Novedrate(CO)  
Piazza Grazioli 18 00186 Roma Italy  
Mail: Sales.IA.Italy@deltaww.com  
TEL: 39 039 8900365

### Russia: Delta Energy System LLC

Vereyskaya Plaza II, office 112 Vereyskaya str.  
17 121357 Moscow Russia  
Mail: Sales.IA.RU@deltaww.com  
TEL: 7 495 644 3240

### Turkey: Delta Greentech Elektronik San. Ltd. Sti. (Turkey)

Şerifaii Mah. Hendem Cad. Kule Sok. No:16-A  
34775 Ümraniye – İstanbul  
Mail: Sales.IA.Turkey@deltaww.com  
TEL: 90 216 499 9910

### GCC: Delta Energy Systems AG (Dubai BR)

P.O. Box 185668, Gate 7, 3rd Floor, Hamarain Centre  
Dubai, United Arab Emirates  
Mail: Sales.IA.MEA@deltaww.com  
TEL: 971(0)4 2690148

### Egypt + North Africa: Delta Electronics

Unit 318, 3rd Floor, Trivium Business Complex, North 90 street,  
New Cairo, Cairo, Egypt  
Mail: Sales.IA.MEA@deltaww.com